

Testing Solutions for Protection, Automation and Control Systems

Product Catalog

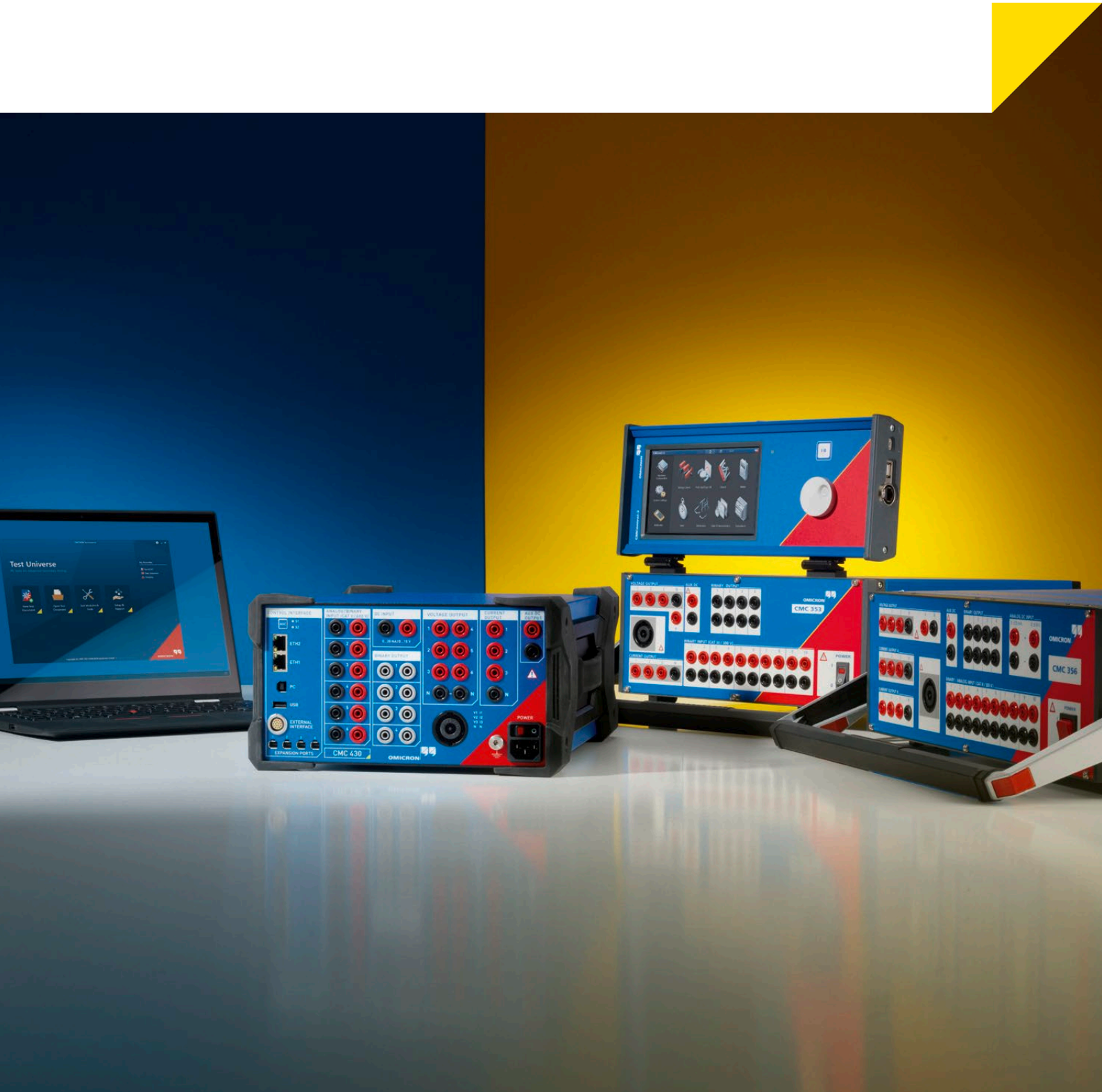

The company

OMICRON is an international company serving the electrical power industry with leading testing solutions. The application of OMICRON products allows users in more than 160 countries to test their protection, measurement, and primary equipment with complete confidence.

Continuous innovation

For more than 25 years, innovations from OMICRON have set new standards in secondary injection testing. The CMC test equipment led the way with many advances such as the first use of the phasor diagram, the first IEC 61850 implementation and many more, while RIO, the Relay Interface of OMICRON, and its successor, XRIO, established yet another industry standard. With the patented OMICRON Control Center technology, automated testing of protective relays was revolutionized. With the future-oriented system-based protection testing approach, users can easily achieve a particularly high depth of testing.

Excellent knowledge base

OMICRON's engineers understand the needs of their customers and continue to develop solutions for the world's power systems. Regular user meetings provide platforms for the exchange of information and experiences. OMICRON shares this expertise through its membership of many international standardization bodies. The provision of extensive expert knowledge and worldwide application oriented training helps customers to achieve cost effective testing and commissioning.

First class quality

Customers rely on the company's ability to provide products of the highest quality which OMICRON is constantly striving to achieve. The commitment and unique spirit of a team of excellent employees is the company's greatest asset. Winning the "Great Place to Work" award represents international recognition of the standards it attains in its working environment.

Extraordinary customer support

With an extensive network of company offices, distributors and representatives around the world, OMICRON is always accessible to its customers for individual attention. Extraordinary customer support and long term customer relationships ensure trust and successful co-operation.

CMC Test Set Overview	4	ADMO	39
Operating Options		Overview of Technical Specifications	
Test Universe	6	CMC 356.....	40
CMControl P	8	CMC 256plus.....	42
RelaySimTest.....	8	CMC 430.....	44
Test Universe		CMC 353.....	46
OMICRON Control Center	10	CMC 310.....	48
Pause Module, Text View, ExeCute	10	CMC 850.....	50
XRIO.....	11	CMControl P	51
PTL – Protection Testing Library.....	11	Accessories	
QuickCMC.....	12	Standard CMC test set accessories	52
State Sequencer	13	CMC wiring accessory package.....	53
TransPlay.....	14	Mini wireless USB adapter.....	53
Harmonics.....	14	Generator combination cable	53
Binary I/O Monitor	14	Transport cases.....	54
CB Configuration	15	Trolley / Backpack.....	54
Ramping.....	15	CMGPS 588 – Synchronization unit.....	55
Pulse Ramping.....	15	CMIRIG-B – IRIG-B interface	55
Overcurrent	16	TICRO 100 – PTP time converter.....	55
Overcurrent Characteristics Grabber	16	OTMC 100p – PTP grandmaster clock.....	55
Distance.....	17	EMCON 200 – Ethernet media converter.....	55
Advanced Distance.....	17	TWX1 – Testing traveling wave relays.....	56
VI Starting.....	19	CPOL2 – Polarity checker	56
Autoreclosure	19	CMLIB A – Low level signal connector.....	56
Single-Phase Differential	19	RIB1 – Low level isolation box.....	56
Advanced Differential.....	20	CMLIB 7Sx8 – Interface adapter	56
Annunciation Checker.....	21	CMLIB REF6xx – Interface adapter	57
Power	22	REF 54x – Cable connector for REF 54x	57
Advanced Power.....	22	ISIO 200 – Binary I/O terminal	57
Advanced TransPlay	23	RXB1 – Binary output extension.....	57
Transient Ground Fault.....	24	LLX1 – Low level output accessory	58
NetSim	24	LLX2 – Low level output accessory	58
Synchronizer.....	25	LLX3 – Low level output accessory	58
Meter.....	26	LLX4 – Low level output accessory	58
Transducer	27	VBO3 – Voltage transformer.....	59
PQ Signal Generator	28	CMTAC 1 – AC to DC trigger rectifier.....	59
CMControl P	29	C-Probe 1 – Current clamp.....	59
RelaySimTest	30	C-Shunt.....	59
EnerLyzer / EnerLyzer Live, TransView	32	ARC 256x – Arc flash initiator.....	59
CMEngine	34	SER 1 – Scanning equipment for relays	60
IEC 61850 Testing & Cybersecurity		SEM – Scanning equipment for meters.....	60
StationScout.....	35	Recloser and Sectionalizer Control Test Cables	61
IEDScout	36	Further Testing Solutions	
StationGuard.....	36	CMS 356	62
MBX1	36	COMPANO 100.....	62
RBX1	36	ARCO 400.....	62
GOOSE Configuration.....	37	DANEO 400	62
Sampled Values Configuration	37	CPC 100	63
IEC 61850 Client/Server	37	CT Analyzer.....	63
DANEO 400	38	VOTANO 100.....	63
SVScout.....	38	CIBANO 500	63
ISIO 200.....	38		

CMC Test Set Overview

Making use of leading-edge technology in both development and quality assurance, OMICRON sets new standards for advanced secondary testing equipment in terms of flexibility, accuracy, portability and reliability. Depending on their requirements in this field of application, users can choose the ideal device from the CMC test set family¹.

Various operating options are available for the CMC devices:

- > The high-performance PC software Test Universe offers an enormous range of functions with its numerous application-optimized test modules and the Protection Testing Library (PTL). Flexible combination options in test plans allow for a high degree of time-saving automation.
- > With RelaySimTest, users can easily achieve a high depth of testing due to its system-based approach with an integrated network simulation.
- > With CMControl, an option for manual testing is provided which is ideally suitable for quick and easy testing.
- > For special fields of application, users can develop their own operating programs for CMC test sets with the programming interface CM Engine.

The control of the CMC test set is established via wired Ethernet, USB or Wi-Fi².



CMC 356 – Universal protection test set and commissioning tool

The CMC 356 is the universal solution for testing all generations and types of protection relays. Its powerful six current sources (three-phase mode: up to 64 A / 860 VA per channel) with a great dynamic range, make the device capable of testing even high-burden electromechanical relays. Commissioning engineers will particularly appreciate its ability to perform wiring and plausibility checks of current transformers, by using primary injection of high currents from the test set. The CMC 356 is the first choice for applications requiring the highest versatility, amplitude and power.

- > 6 x 32 A / 430 VA
- > 3 x 64 A / 860 VA
- > 1 x 128 A / 1000 VA
- > 4 x 300 V
- > 1 x 32 A / 1740 VA



CMC 256plus – High precision protection test set and universal calibrator

The CMC 256plus is the first choice for all test applications where six current outputs and high voltage amplitudes combined with a particularly high accuracy are required. This unit is not only an excellent test set for protection devices of all kinds, but also a universal calibration tool. Its high precision allows the calibration of a wide range of measuring devices, including: energy meters of class 0.2S, transducers, power quality measurement devices and phasor measurement units (PMU). Its unique accuracy and flexibility make the CMC 256plus ideal for protection and measurement equipment manufacturers for research and development, production and type testing.

- > 6 x 12.5 A / 80 VA
- > 3 x 25 A / 160 VA
- > 4 x 300 V
- > Error < 0.015 % (rd.) + 0.005 % (rg.) typ.

¹ Detailed technical specifications see pages 40 – 50. Find detailed ordering information and package descriptions on www.omicronenergy.com.

² Wi-Fi is subjected to technical and legal constraints. For more information please contact your local OMICRON office or sales partner.

CMC 430 – Ultra-portable protection test set and calibrator



The CMC 430 is the preferred choice for test engineers in cases where transportability is a priority and three currents up to 12.5 A and six 150 V voltage outputs are sufficient. With its low weight of just 8.7 kg (19.2 lbs) and the robust design with protected edges, the device is perfect for indoor and outdoor use. With an extraordinarily high precision, it is also an ideal source-based calibrator for all kinds of measurement devices such as energy meters, transducers, PQ meters, and PMUs. The CMC 430 combines its outstanding performance as a relay tester and calibrator with hybrid measurement and recording facilities (analog, binary, IEC 61850 GOOSE messages and Sampled Values).

- > 3 x 12.5 A / 96 VA
- > 1 x 37.5 A / 150 VA
- > 6 x 150 V
- > Error < 0.015 % (rd.) + 0.005 % (rg.) typ.

CMC 353 – Powerful tool for three-phase protection testing



With its compact design and low weight of 13.3 kg (29.3 lbs), the CMC 353 provides the perfect combination of portability and power. It is the ideal test set for three-phase protection testing and the commissioning of SCADA systems. The powerful current outputs (3 x 32 A / 430 VA) support 5 A relay testing as well as testing of electromechanical relays in an optimal way. The portable design makes this device an excellent choice for commissioning and maintenance tasks, particularly in industry, distributed generation, and medium and low voltage applications. It meets a wide variety of challenges in protection engineering – from testing electromechanical relays to the latest IEC 61850 IEDs.

- > 3 x 32 A / 430 VA
- > 1 x 64 A / 860 VA
- > 4 x 300 V

CMC 310 – Compact protection test set for easy manual testing



The CMC 310 is specifically designed for manual three-phase testing of protection and measurement devices with CMControl P. The lightweight and compact design makes the CMC 310 particularly suitable for testing distribution and industrial systems. If automated testing is requested, a CMC 310 can be upgraded to a CMC 353 at any time.

- > 3 x 32 A / 430 VA
- > 1 x 64 A / 860 VA
- > 3 x 300 V



CMC 850 – Protection test set dedicated to IEC 61850

The CMC 850 focuses specifically on IEC 61850 systems. It communicates with the test object using the real-time protocols GOOSE and Sampled Values. The test set is operated either with the Test Universe software or with RelaySimTest.

Because of its focus on IEC 61850 applications, the device is particularly small and lightweight.

Operating Options



Test Universe

The powerful Test Universe PC software releases the full potential of the CMC test sets¹. It offers a wide range of application-optimized test modules, enabling the user to achieve a high degree of automation and standardization. Users have access to OMICRON's extensive test template library, or they can create comprehensive test plans themselves or order customized templates from OMICRON.

Testing of specific protection and measurement functions

Test Universe provides a variety of automated testing possibilities in dedicated modules especially designed for individual test object functions, e.g. for testing overcurrent relays, distance relays, or differential relays.

In these modules, a specific graphic representation of the protection device's characteristic (I/t diagram, impedance plane, etc.) allows the graphical definition of test specifications as well as the visualization of the test results directly in the relay's characteristic diagram. Tailor-made test modules are also available for meters, transducers and power quality meters/analyzers.

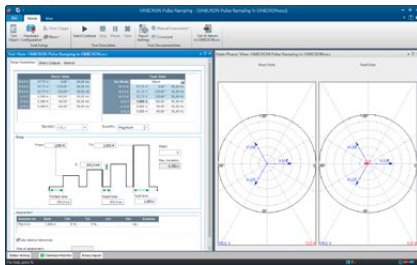

General functionality

For creating and performing special tests not covered by the function related modules, the Test Universe software also comprises generic test modules.

Such tests, for instance, can be:

- > sequences of output states – controlled by time or the reaction of the relay under test with assessments based on time measurements
- > linear or pulsed ramping of electrical quantities with assessment based on the level of starting or resetting
- > manual testing by direct setting and output of voltage and current values, phase angles, frequencies, etc. either numerically or in the phasor diagram.

Besides the generic test modules, OMICRON offers a wide variety of additional software that works with the CMC test sets (e.g. IEC 61850 testing solutions).

OMICRON Control Center – Test plans for multifunctional test objects

In order to test the many functions of digital relays, the OMICRON Control Center (OCC) technology allows the combination of individual test modules into an overall test plan. When performing a test, each embedded module will be executed sequentially and an overall test report including the results of all the functions tested is created automatically.

Since the test documents hold the complete test specification – i.e. the nominal behavior (settings) of the test object, the tolerances and the test points, with which this shall be verified – such a document is the basis for the repetition of the same test at a later time by reloading it, clearing the results of the previous test, replaying the test plan and saving the new results.

Thereby tests, which have been created once, can be repeated for maintenance testing. This assures a constant testing quality, facilitates comparison of results, and saves time when performing routine tests. Existing tests can also be adapted easily to test similar test objects.

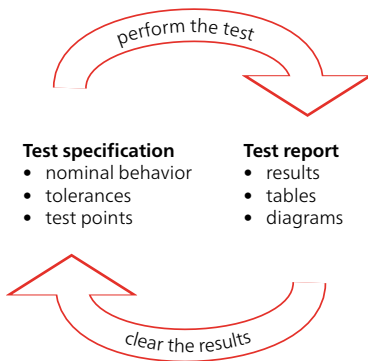

¹ CMC 356, CMC 256plus, CMC 430, CMC 353 and CMC 850

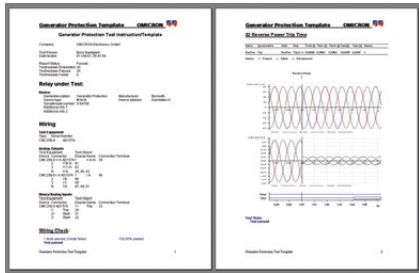

Automatic reporting

All test modules of the Test Universe software have a common element – the reporting function: each module provides a fully formatted test report. Depending on the module the results come from, data is entered in tabular and/or graphical form. If several modules are used within the OCC to comprise a test, each module adds its specific piece of data to the overall report. After testing is finished, test results and assessments are entered automatically to complete the report. Reports can easily be printed, stored, or exported to standard office applications using Rich Text format (RTF) and TXT format.

Customizing test reports based on individual requirements is easy. The visible content of test reports can be defined independently from the recorded data, by just selecting or deselecting items from the list. Recorded data will always remain available in the test file, regardless of whether the user chooses to include them in the reports. Defined report settings are quickly and easily generated, saved with a form name, and reloaded at a later time; company specific elements like logos etc., can easily be included.

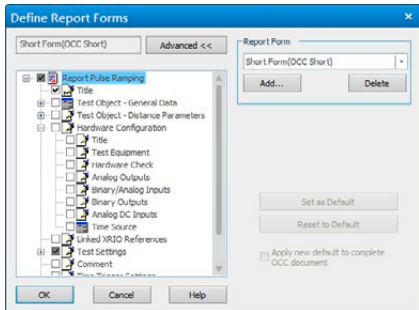

Exporting test results: Besides the standard export formats TXT and RTF for further use of the data, such as in Microsoft Word, OMICRON Control Center documents provide the following two export formats for more extensive external post-processing of test data: the well-known CSV format and XML (Extensible Markup Language). CSV and XML Data Export are also available in all test modules in stand-alone mode. XML is a text-based data format that supports a non-proprietary method of interfacing the test data with any third-party database (e.g. Microsoft Access, Microsoft SQL Server).

Protection Testing Library

For mastering the challenge of testing modern multifunctional relays, OMICRON provides a library of protection testing templates, the Protection Testing Library (PTL). This library offers customers access to test plans preconfigured for the most common relays types of various manufacturers (ABB, Alstom, Areva, GE, Reyrolle, Schneider, SEL, Siemens, Toshiba, etc.), which include

- > relay modeling – i.e. calculation of the characteristics (such as zone diagram, ...) and tolerances from the relay settings – taking into account the technical characteristics as specified in the relay manual
- > import filter for importing setting values from the relay's software or from setting calculation tools
- > test routine for common relay functions.

This not only helps to save the time normally needed to manually create the relay characteristics and test templates but also let users benefit from OMICRON's testing know-how on how to model and test specific relays and their functions in the Test Universe software. New templates are continuously being added to the PTL and are available for customers to download from the OMICRON website.

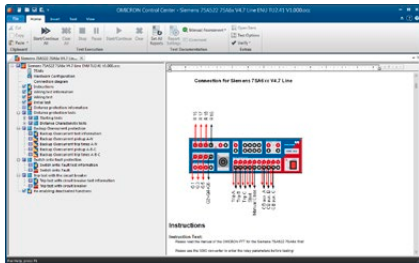

Languages

Test Universe is available in 16 standard languages. Changing the system language is possible at any time just by selecting the requested language in the "language selection". All languages are automatically installed; no installation of any additional software components is required.

Especially in international projects, clients many times wish to get a report in a different language than the commissioning engineer's preferred working language. This is easily possible for all available standard languages. When the system language is changed and an existing test document is re-opened, the test report is automatically switched to the new system language set.

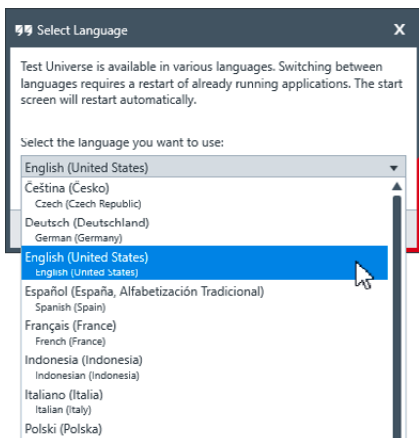

Operating Options

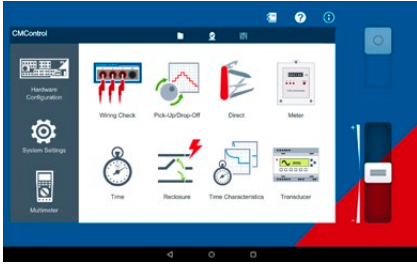

CMControl P

CMControl P is a control option for CMC test sets which is specifically designed for easy manual testing of protection and measurement devices. It is available as an App for Windows PC or Android tablets and as a dedicated front panel control device. The included test tools with integrated fault models guarantee quick and convenient tests. Due to its intuitive user interface and innovative user guidance there is no need for special training.

CMControl P can be ordered with a CMC test set either standalone or in combination with a Test Universe package (see pages 9 and 29).

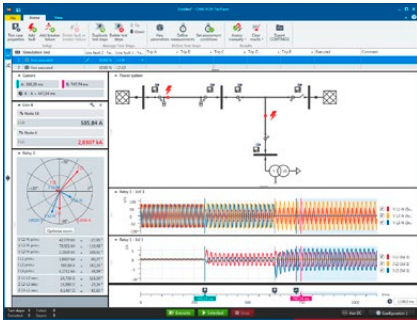

RelaySimTest

RelaySimTest is a software solution for system-based protection testing with OMICRON test equipment that takes a novel, future-oriented approach: the test is independent of relay type and relay manufacturer and the often very extensive parameter settings. Instead, it completely focuses on the correct behavior of the protection system. This is made possible by simulating realistic events in the power system. With RelaySimTest's flexible grid editor, power networks can be simulated intuitively.

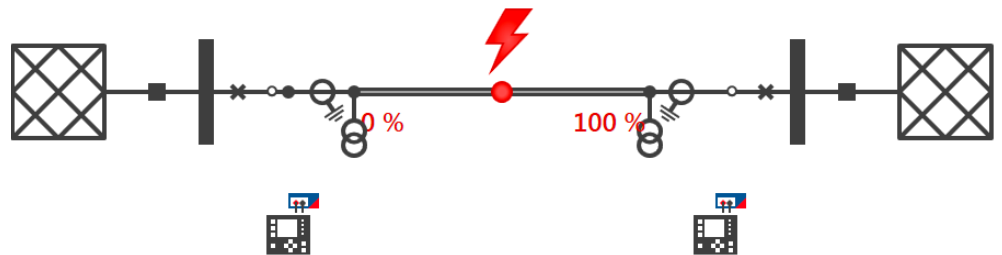

Compared to conventional test methods (such as settings-based testing with Test Universe), RelaySimTest can detect errors in the settings, logic and design of the protection system much better. This allows testers to verify the correct behavior of their protection system faster and with a higher testing quality than ever before. Complementary to testing with Test Universe, RelaySimTest contributes to a more reliable power system.

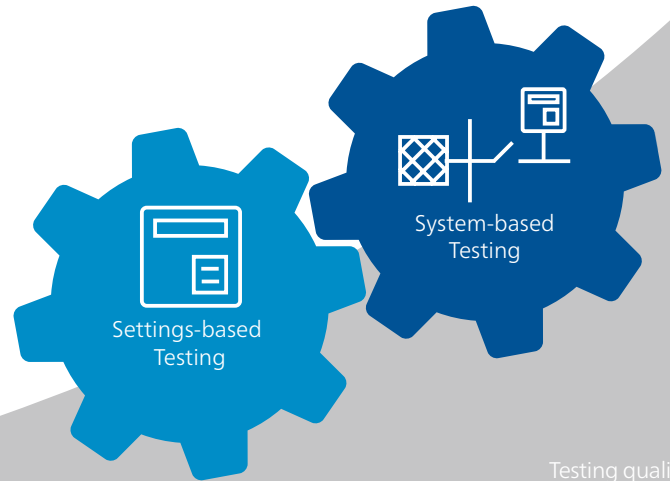

Test Universe Package Overview



For the combination of CMC test sets (CMC 356, CMC 256plus, CMC 430 and CMC 353) and Test Universe software, four different packages as well as optional add-ons are offered, which are tailored to diverse focal points of use. Each of these packages contains a selection of software modules that can be either used independently from each other for single tests or be embedded into test plans for automated testing:

- Essential** offers a good introduction with basic functions and modules; can serve as a base for custom compiled packages
- Standard** contains all modules that are typically used for settings-based testing of protection devices
- Enhanced** like Standard, specifically extended by functions for system-based testing and transient simulation as well as for free programming
- Complete** covers all functions and software modules that are offered for controlling CMC test sets

A package can be extended at any time by ordering additional single modules or optional add-ons.

		Packages				Add-ons			
		Essential	Standard	Enhanced	Complete	Measurement Equipment Testing	IEC 61850 Basic	IEC 61850 Advanced	
Test Universe modules	OMICRON Control Center ¹	Automation tool, document-oriented test plan, template and report form	■	■	■	■			
	QuickCMC	Convenient manual testing in the Test Universe environment	■	■	■	■			
	State Sequencer	Determining operating times and logical timing relations by state-based sequences	■	■	■	■			
	TransPlay	Playback of COMTRADE files, recording of binary input status	■	■	■	■			
	Harmonics	Generation of signals with superimposed harmonics	■	■	■	■			
	CB Configuration	Module for setting the CB simulation	■	■	■	■			
	Ramping	Determining magnitude, phase, and frequency thresholds by ramping definitions	■	■	■	■			
	Pulse Ramping	Determining magnitude, phase, and frequency thresholds by ramping definitions	□	■	■	■			
	Overcurrent ²	Automatic testing of positive/negative/zero sequence overcurrent characteristics	□	■	■	■			
	Distance	Impedance element evaluations using single-shot definitions in the Z-plane	□	■	■	■			
	Advanced Distance	Impedance element evaluations using automatic testing modes	□	■	■	■			
	VI Starting	Testing of the voltage dependent overcurrent starting function of distance relays	□	■	■	■			
	Autoreclosure	Testing of the autoreclosure function with integral fault model	□	■	■	■			
	Single-Phase Differential	Single-phase tests of the operating characteristic and the inrush blocking	□	■	■	■			
	Advanced Differential	Comprehensive three-phase differential relay testing (four modules)	□	■	■	■			
	Annunciation Checker	Verification of the correct marshalling and wiring of protection devices	□	■	■	■			
	Power	Testing with visualization and assessment in the P-Q plane (basic)	□	■	■	■			
	Advanced Power	Testing with visualization and assessment in the P-Q plane (enhanced)	□	■	■	■			
	Advanced TransPlay	Playback and processing of COMTRADE, PL4, or CSV files	□	■	■	■			
	Transient Ground Fault ³	Simulation of ground-faults in isolated or compensated networks	□	□	■	■			
	Synchronizer	Automatic testing of synchronizing devices and synchro-check relays	□	□	■	■			
	Meter	Testing of single and multifunction energy meters	□	□	□	■	■		
	Transducer	Testing of measurement transducers	□	□	□	■	■		
	PQ Signal Generator	Simulation of power quality phenomena according to IEC 61000-4-30 and IEC 62586	□	□	□	■	■		
	IEC 61850 Client/Server	Automatic SCADA testing in accordance with IEC 61850	□	□	□	■		■	■
	GOOSE Configuration	Testing with GOOSE according to IEC 61850	□	□	□	■		■	■
	Sampled Values Configuration	Testing with Sampled Values according to IEC 61850-9-2 ("9-2 LE") and IEC 61869-9	□	□	□	■			■
	Additional tools	CMControl P App	Quick and easy manual testing of protection and measurement devices	□	■	■	■		
RelaySimTest ³		System-based protection testing by simulating realistic power system events	□	□	■	■			
Adv. Transformer Features		Advanced transformer features for differential protection in RelaySimTest	□	□	□	■			
CMEngine		Programming interface for controlling CMC test sets with user specific software	□	□	■	■			
EnerLyzer Live		Analog measurements and transient recording with CMC test sets	□	□	□	■			
TransView		Transient signal analysis for COMTRADE files	□	□	□	■			
ADMO light ⁴		Asset and maintenance management for protection systems	■	■	■	■			
IEDScout		Universal software tool for working with IEC 61850 IEDs	□	□	□	□		■	■

Contained in all packages: Binary I/O Monitor, AuxDC Configuration, ISIO Connect (for ISIO 200), Polarity Checker (for CPOL2).

¹ Includes licenses for Pause Module, ExeCute, TextView

² Includes license for Overcurrent Characteristics Grabber

³ RelaySimTest license also includes the licenses for Transient Ground Fault and NetSim

⁴ ADMO light is limited to 50 assets but can be upgraded to a full ADMO version at any time

■ Contained
□ Optionally available

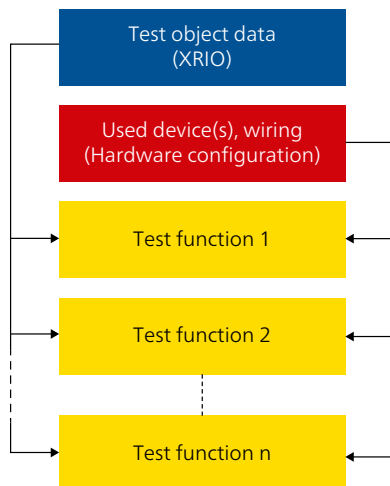

OMICRON Control Center

OMICRON's Test Universe software modules feature comprehensive functionality for conventional testing. With the patented OMICRON Control Center (OCC) technology (Patent Nos. EP 0904548 B1 and US 6418389 B2), they can be combined to test plans within a single document in a unique manner. Such test plans can easily be built, maintained and distributed.

Basically, an OCC document comprises the following elements:

- Test object data** Defined in XRIO format, a powerful test object environment to describe/model all test object parameters and settings. Test object data can be entered manually or be imported. XRIO converters make the setting transfer from the relay to the test software fast and easy.
- Information on the device(s), outputs and inputs, wiring connections** Specified in the Hardware Configuration. Present throughout a test plan for all embedded test functions/modules.
- Test modules with test settings (test points, etc.)** Number and type of embedded test modules depending on the kind of the tests to be performed. Tests automatically adapt to changed test object settings, as these are transferred from the overall test object definition. With the LinkToXRIO technology, the user has access to all relay parameters – including user-defined additional settings – and can use them for the definition of the test points and assessment conditions.
- Optional: Graphics, instruction texts, etc.** Guide the tester through the testing process according to test specifications (connection diagrams, check instructions, etc.) supported by Pause Module, Text View, ExeCute.
- Report (after testing)** Automatically created test report, containing all test results in secure format with exact data. Automatic assessment of the test points according to tolerances. Customizable to meet the organization's requirements. Test results can be exported in RTF, TXT, CSV, and XML format.

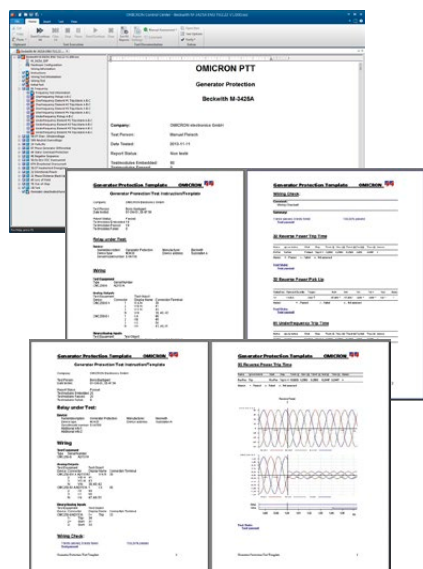

Re-usability

OMICRON Control Center documents can easily be used as templates for the same or similar test objects: Simply copying the OCC file, deleting the results of the previous test and restarting will perform the test again with the exact same settings, configuration, and test specifications. For similar tests, where only the settings differ (e.g. in substations with several feeders), simple copying of the OCC file and adjustment of the parameters is all that is required. Thus, testing times can be significantly reduced.

Pause Module, Text View, ExeCute

The following useful tools run within OCC and support the automation of test plans:

Pause Module

Allows the setting of breakpoints in automatic tests. Test designers can specify instructions to be displayed as pop-up messages (e.g. inclusion of a wiring diagram).

Text View

Allows for embedding and displaying a text file or log file during an automatic text execution.

ExeCute

Allows for execution of external applications (programs) along with file or data parameters during Control Center execution for an automatic test using an OCC document (e.g. automatic change of the relay settings during type testing).

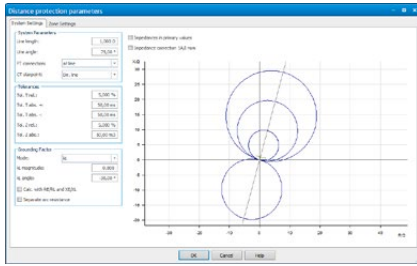

Test object definition with XRIO

All the relevant data for a device to be tested is kept in the XRIO (eXtended Relay Interface by OMICRON) format. The corresponding data can either be manually entered or alternatively be imported. Test object parameters can also be exported, making them available for other test plans.

LinkToXRIO

LinkToXRIO allow test modules the direct use of a defined test object parameter for testing. If a certain parameter changes, the test plans using it do not need to be modified. The test plans will perform their specified test then using the modified parameter.

XRIO converters

XRIO converters allow for the efficient conversion of the data available in the relays' own parameter structure. The growing library of relay-specific XRIO converters provides data models of the protection characteristics and tolerances (e.g. impedance zones, I/t diagram shape, etc.) based on the protection parameters and technical details documented in the manual of the particular protection device.

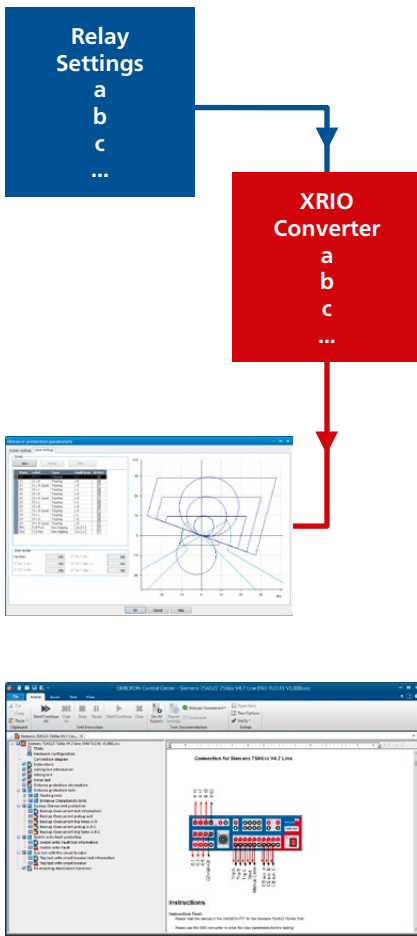

PTL – Protection Testing Library



OMICRON's innovative test software technology with the OMICRON Control Center, XRIO, and LinkToXRIO enables all users to create relay specific test templates that adapt to the actual parameterization of the relay. This is the technological basis of the Protection Testing Library (PTL). The library gives the protection engineers the possibility to benefit from the work that OMICRON spends to model multifunctional protection devices and to build test plans, and thus from the resulting testing know-how.

This library provides OMICRON customers free access to prepared test plans and relay models (XRIO Converters) as well as parameter import filters for specific protection devices. Any user can easily extend or customize the test plans or XRIO converters to meet individual requirements.

The PTL is extended and maintained on a constant basis. The library for example provides access to templates and XRIO converters for line, power transformer, and generator protection relays. Specific relay types of ABB, Alstom, GE, Mitsubishi, Reyrolle, Schneider, SEL, Siemens, Toshiba, and other manufacturers are supported.

Benefits:

- > Save work and time: save the time it normally would take to manually create the relay characteristics and test templates. The relevant relay parameters can be readily entered into the XRIO converter to view and test against that particular relay's characteristics.
- > Parameter import: relay parameters can be transferred manually or automatically (e.g. by using the parameter import filters for the different relay types).
- > Knowledge source: often relays have special behavior that makes testing challenging and time consuming. By using PTL files users benefit from OMICRON's application know-how.
- > No programming: the PTL test templates do not require any programming or scripting.
- > Open system: the PTL templates and XRIO converters are completely open. In this way, users can adapt a template to exactly match their needs.

The PTL is integral part of the Test Universe software standard delivery and available for free download in the Customer Portal of the OMICRON website.

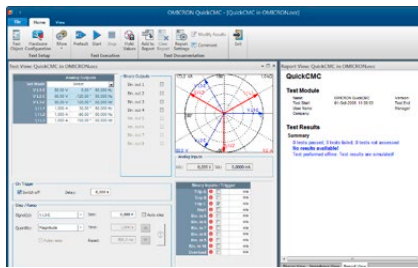

QuickCMC

Quick and easy PC controlled manual testing

- > Simultaneous control of all available test signals (voltage and current outputs) of the CMC test set in magnitude, phase, and frequency (max. 22 channels possible¹)
- > Steady state, step or ramp function for all quantities
- > Fault Calculator providing different operation modes
- > Timing measurements
- > Vector view and impedance plane

QuickCMC provides an easy and intuitive user interface, while also offering powerful functions for performing PC controlled manual tests for all kinds of protection relays, measurement transducers and other equipment.

Analog Outputs			
Set Mode	Fault values		
Fault Type	L1-L2-L3		
V Fault	57,73 V	90,00 °	50,000 Hz
I; I Fault	2,000 A	10,00 °	50,000 Hz
Angle(V-I)		80,00 °	

Analog Outputs			
Set Mode	Z%-I const.		
Fault Type	L1-E		
Z%	10 %	Line length	
Phi Z	4,00 °	Link to line angle	
ITest	2,000 A		

Analog Outputs			
Set Mode	Powers		
S1 (P1 , Q1)	50,00 W	-16,67 var	50,000 Hz
S2 (P2 , Q2)	50,00 W	-16,67 var	50,000 Hz
S3 (P3 , Q3)	50,00 W	-16,67 var	50,000 Hz
Sv (P , Q)	150,0 W	-50,00 var	50,000 Hz
V L1-E	57,73 V	0,00 °	50,000 Hz
V L2-E	57,73 V	-120,00 °	50,000 Hz
V L3-E	57,73 V	120,00 °	50,000 Hz

Output functions

Output quantities can either be entered in the classical way as voltages and currents, or by using input modes for absolute or relative impedance values, powers or symmetrical components. They may be defined numerically, or by dynamically positioning the elements in the phasor diagram or the interactive impedance plane with the mouse.

Fault Calculator

QuickCMC includes the Fault Calculator which automatically converts the entered values to determine the correct output quantities (voltage, current and phase angle) for single-, two- and three-phase faults, power flow, or symmetrical components. The residual voltage and current is also automatically calculated and generated. According to the selected mode, the values are displayed graphically in the vector or impedance view, as well as numerically in a table.

Channels where no fault model is assigned can be set without any restriction (unbalanced signal generation, variable frequency for each individual channel, etc.). The Unit Manager function allows for easy toggling between the handling of values in primary/secondary, absolute/relative, or seconds/cycles.

Step or Ramp Mode

Step or Ramp Mode operation is provided for finding limiting values, such as pick-up and drop-off, or starting of a relay. In Step Mode, the selected quantities (currents, voltages, impedances, power, etc.) are increased or decreased by a specified value with a mouse click. In Ramp Mode, the defined step is repeated until an input toggles (e.g. when the relay trips). The pulse ramping functionality allows easy testing of protection elements with overlapping characteristics (e.g. testing the high level current threshold).

Input/measuring functions

The test set's binary inputs can be used to monitor dry or wet contacts and make corresponding time measurements. In addition, virtual binary input signals (assigned to GOOSE messages) are supported.² The time measurement may alternatively trigger on the external interruption of the generated currents, allowing direct assessment of CB contacts. The output values of a transducer connected to the analog DC inputs can also be displayed.

Reporting

Results of tests with QuickCMC can be stored for later use. Similar to all other testing modules in the Test Universe software, the report style and content can be customized. In addition, the QuickCMC reporting feature provides a "notepad" function, so that individual comments may be added to the report.

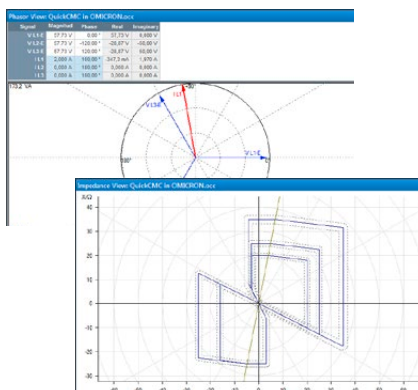

¹ For CMC test sets equipped with LLO-2 option

² GOOSE Configuration module is required

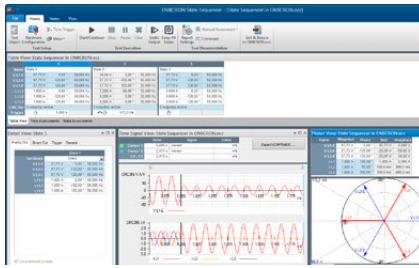

State Sequencer

State Sequencer is a very flexible test module for determining operating times and logical timing sequences. A state is defined by the output conditions (voltages and currents, binary outputs) and a condition for the transition to the next state. Several individual states can be put together consecutively in order to define a complete test sequence. The transition from one state to the next may take place after a fixed time, triggered by a manual input, after the occurrence of a trigger condition at the binary inputs of the CMC, or after a GPS or IRIG-B trigger (e.g. for synchronized end-to-end testing with multiple CMCs). Looping of the sequence or static output of individual states is also possible.

Definition of individual states

Within one state, all configured test signals (voltage and current outputs) of the used test device can be set independently in amplitude, phase, and frequency. Besides the direct input of the individual voltages and currents, the integrated Fault Calculator allows the automatic calculation of the test quantities. These can be entered as fault values, power values, symmetrical components, or impedances (with constant test current, constant test voltage or constant source impedance model). For distance relays, test points can directly be defined in the interactive impedance plane showing the nominal characteristic of the test object.



Measurement

Time measurement conditions can be defined to check the correct operation of the relay. Individual response times and tolerances can be specified for each measurement condition, allowing a fully automatic assessment of the results. If the measured time is within the tolerance range, the test is "passed"; otherwise, it is "failed".

Apart from timing measurements (always triggered by an event, e.g. a trip) state assessment(s) can be made. A state assessment is positive, if defined states at the relay outputs connected to the binary inputs are logically true throughout a certain state.

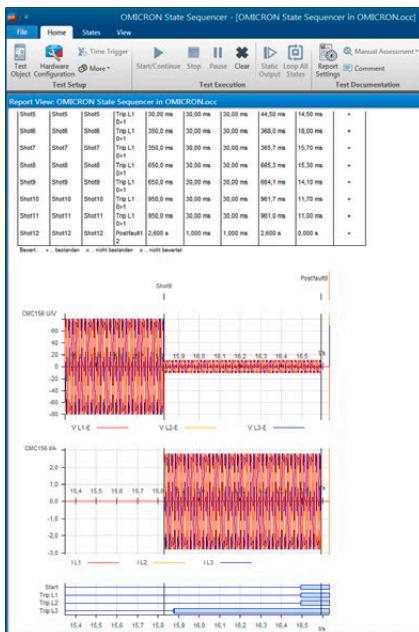

Assessment and reporting

The measurement conditions are displayed in a table. After a test execution this table also contains the actual measured times and deviations and the automatic assessment of the results. The last column contains the "passed" or "failed" information. All of the time signals (voltages, currents and binary inputs) can be displayed graphically to aid in studying the reaction of the relay. Signals can be enabled individually, with the ability to zoom in on specific points in time. Data cursors facilitate scrolling through the time signals to find the values at specific times.

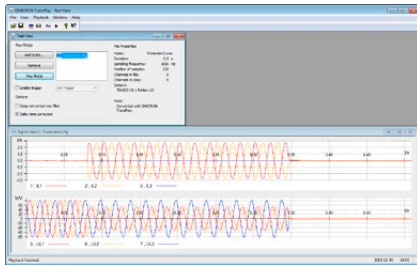

TransPlay

TransPlay allows the loading and playback of transient files containing voltage and current analog transient waveforms. COMTRADE files can be automatically played back. This results in the injection of these signals into the relay. These signals may be simple harmonic waveforms or actual power system faults recorded from a digital fault recorder or calculated by a simulation program, such as EMTP. The playback length is only limited by the capacity of the hard disk.

The software supports the following file formats:

- > IEEE COMTRADE (C37.111-1991 and P37.111/D11-1999) respectively IEC 60255-24 (for replaying records with multiple sampling rates Advanced TransPlay is required)
- > Microsoft Windows WAV

TransPlay also includes synchronizing capability for use with an external trigger, such as a time pulse from a GPS satellite receiver (e.g. CMGPS 588 + CMIRIG-B).

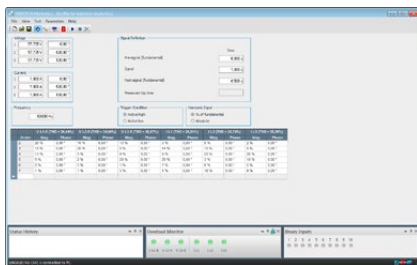

Harmonics

Harmonics generates test signals consisting of a fundamental voltage or current signal and superimposed harmonics. Depending on the used CMC test set, signals with a frequency of up to 3 kHz (i.e. 60th harmonic at 50 Hz or 50th harmonic at 60 Hz) may be generated.

Harmonics allows defining the fundamental of three voltage and three current signals, and – superimposed on those – any combination of even and odd harmonics. The harmonics thereby can be entered either in percentages or absolute values. Harmonic signals can be output directly or exported as COMTRADE files.

Harmonics features both a static output mode and a sequence mode. In sequence mode a sequence consisting of three states can be injected:

1. Pre-signal: fundamental wave
2. Signal: fundamental wave and harmonics
3. Post-signal: fundamental wave

A timer starts at the moment of harmonic injection and stops on a trigger event. The response time is indicated.

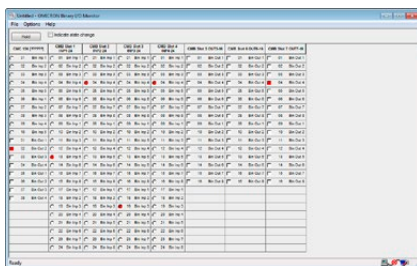

Binary I/O Monitor

Binary I/O Monitor displays the status of all binary inputs and outputs of the connected CMC and binary extension devices as well as virtual binary inputs for GOOSE messages.¹ It can also indicate transient changes that occur between regular updates of the displayed information. This is very useful during the creation of a test sequence or for troubleshooting. A hold function enables the user to “freeze” the display for detailed investigations. In particular when working with binary extension devices and/or GOOSE¹, this tool provides considerable benefit. A typical application is the testing of the control logic of a bay control device.

Main features:

- > All connected binary inputs and outputs are monitored
- > Runs in parallel with any OMICRON test module
- > Transient changes can be indicated through the “Indicate state change” function
- > Display can be frozen by the “Hold” function

¹ GOOSE Configuration module is required

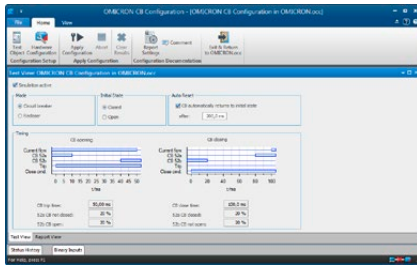

CB Configuration

Essential Standard Enhanced Complete

CB Configuration simulates the auxiliary contacts of a circuit breaker (CB) or recloser during a test (for relays requiring a connection and operation of those contacts for proper functioning). Depending on the available binary inputs and outputs, it is possible to simulate one-pole and three-pole operation of the CB. The set time response of the circuit breaker is visualized in the test view of the module. The actual simulation is controlled by the CMC firmware, allowing real-time responses of the simulated auxiliary CB contacts (52a, 52b) to trip and close commands.

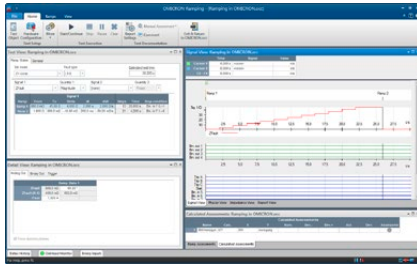

Ramping

Essential Standard Enhanced Complete

Ramping determines threshold values, such as minimum pick-up or switching hysteresis (e.g. pick-up/drop-off ratio). It generates ramps of magnitude, phase, or frequency for the current and voltage outputs. Automated tests can be performed with ramps that allow testing of both simple and complex functions. The flexibility of this module allows two synchronized simultaneous ramps of different variables (including ramping two components of the same output signal, e.g. magnitude of fundamental and harmonic) with any number of ramp segments.

Features:

- > Automated testing using ramp sequences
- > Simultaneous ramps for two independent variables and functions (e.g. V/Hz)
- > Definition of an arbitrary number of consecutive ramp segments
- > Visual control of the output values (time signal view)
- > Test repetition feature with statistic calculations
- > Ratio calculations of the two ramp values, e.g. pick-up/drop-off ratio
- > Unique step-back feature for quick and accurate testing
- > Display of the test results with automatic result assessment

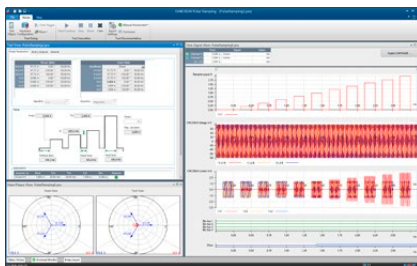

Pulse Ramping

Essential Standard Enhanced Complete

With Pulse Ramping, quick, accurate and thorough determination of pick-up values of multi-functional relays is easily done. Pulse Ramping allows for testing a protection element pick-up value without disabling associated functions. This eliminates a potential source of error. The use of Pulse Ramping also avoids high continuous testing current for electromechanical relays with high instantaneous settings.

Typical applications: Pick-up testing of

- > multifunctional relays with overlapping elements
- > overcurrent relays with multiple elements
- > generator and motor protection
- > rate of change relays (including df/dt)

Application example Overcurrent:

Often overcurrent protection is realized with two stages; a standard stage with a longer tripping time and a high set stage with a very short trip time. With Pulse Ramping, a test of the pick-up value of the high set stage can be done easily: the pulse length is set shorter than the standard stage tripping time and so pulse ramps do not force a trip of this stage.

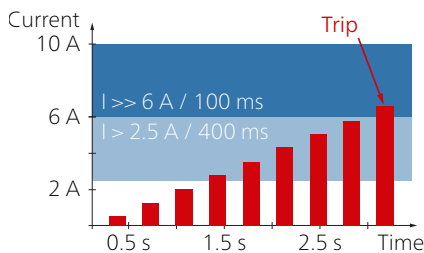

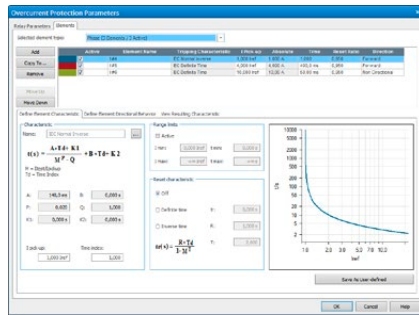

Overcurrent

Overcurrent is used for automatic testing of directional and non-directional overcurrent relays with auto-assessment of the trip time characteristic, the directional boundaries of the current stages, and the pick-up/drop-off ratio. With its flexible directional boundary definition it is also perfect for testing the characteristic of steady-state ground fault relays.

The test module supports directional sector definition and any number of line, ground, positive sequence, negative sequence, and zero sequence elements. For each element the trip characteristic can be individually selected and displayed in the I/t diagram and the directional diagram.

In Overcurrent, the set of test shots can be defined concurrently for all desired fault loops. This is possible for the following fault types:

- > Line-to-line fault
- > Line-to-ground fault
- > Line fault with suppressed residual current (for individual phase testing without ground starting)
- > Negative sequence
- > Zero sequence

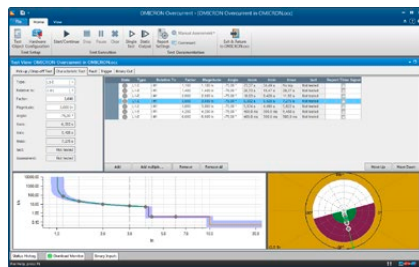

The software overlays the characteristics of each of the elements in both the I/t diagram and the directional diagram. This includes all of the elements which respond to the type of fault applied. For each test shot an assessment of the relay's performance is made based on the allowable tolerances for the measurement of the current and the operating time.

Key features

- > Unrestricted characteristic element definition (characteristic type, directional sector)
- > Assessment for each test shot considering all active elements
- > Simultaneous availability of all element types and characteristics
- > Testing of all fault types and loops together in one test module
- > Definition of test point sequences (in terms of fault type, current magnitude variation, and current angle variation)
- > Testing of the pick-up/drop-off characteristic with automatic assessment
- > Testing with or without load current
- > Automatic reporting

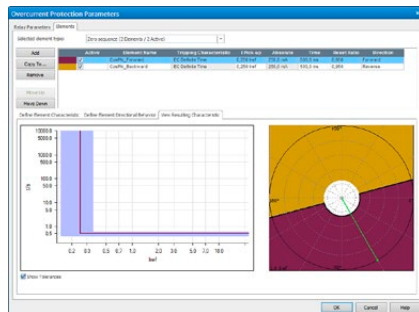

The time characteristics can either be entered directly in current/time tables or based on a wide range of pre-defined relay and recloser characteristics. Hierarchically structured templates for the following relay characteristics are included: inverse-time characteristics as defined by IEC 60255-4 (BS 142), IAC type characteristics, and relay specific curves based on the IEEE equation (PC37.112). Variants of these characteristics support commonly used relay types. Additional variants may be added to the template file, including curves digitized with the Overcurrent Characteristics Grabber (see below). PTL test templates add relay-specific support by mapping the relay settings to the Overcurrent module parameters and providing sample test sequences.

Overcurrent Characteristics Grabber

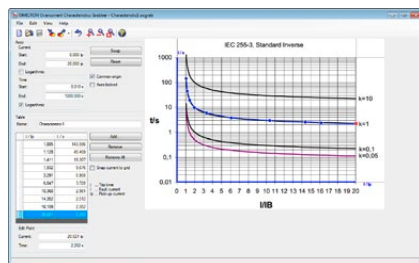

The Overcurrent Characteristics Grabber tool is a supplement to the Overcurrent test module. It helps to extract inverse-time overcurrent relay tripping characteristics from graphical representations. This is most helpful in cases where the characteristic is not known by a given formula but only by a graphical representation, e.g. an image in a relay manual.

This tool loads a scanned image of the characteristics and guides the user through scaling of the I and t axes and successive digitizing of I/t data pairs along the displayed tripping characteristic curve. The resulting characteristics curve value table then is transferred to the Overcurrent test module for performing tests with automatic assessments.

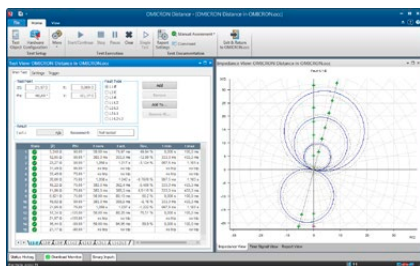

Distance

Distance provides the functionality to define and perform tests of distance relays by impedance element evaluations using single-shot definitions in the Z-plane with graphical characteristic display.

Definition of relay characteristics

The nominal relay characteristics and settings can quickly and easily be defined by a graphical characteristic editor. Starting, trip, extended, and no-trip zones are defined by using pre-defined elements. A complete overview of all defined zones is provided. The standard XRIO interface (see page 11) makes it possible to directly import the relay data from the relay's parameter setting software (if supported by the relay manufacturer). The impedance settings for the zones can be entered and displayed in primary or secondary values.

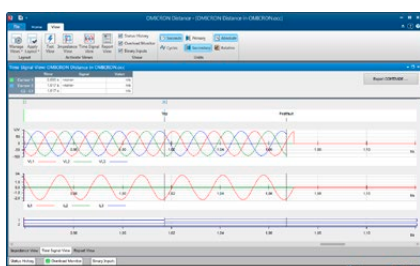

Definition of tests

Tests are defined in the impedance plane by entering the test points to a test point table. This table is divided according to the different fault loops (A-N, B-N, C-N, A-B, etc.). Test points can be defined for several fault loops at the same time (e.g. for all single-phase loops), or for every fault loop separately.

When a test is performed, the test point lists of the individual fault loops are processed sequentially. The reaction of the relay is compared to the specified nominal settings and an automatic assessment is made ("passed" or "failed"). The results are displayed graphically in the impedance plane, as well as numerically in the test point table. For a more in-depth analysis of the results, the voltages and currents related to a test point and the relay's reaction can be graphically displayed. Time measurements between different points can be made using cursors.

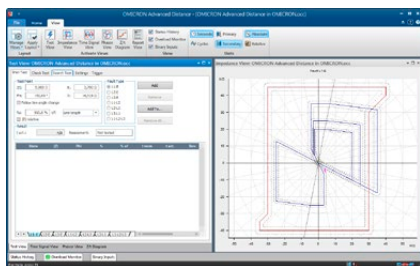

Advanced Distance

In addition to the base functionality of Distance, Advanced Distance provides the following advanced functionality:

- > Search and Check tests of the zone reaches
- > Test settings relative to zone reaches and line angle ("relative shots")
- > Constant source impedance test model
- > Load current superimposition

Shot test, Search test, and Check test

In a Shot test, single test points are added to a test point table and are automatically processed (see Distance).

In a Search test, zone reaches are determined automatically. Zone transitions are searched along search lines specified in the impedance plane, using an optimized algorithm. It is possible to define a series of search lines. All defined search lines are stored in a table for automatic processing.

In a Check test, test points are automatically set at the tolerance boundaries of zones. The setup is done with test lines (check lines) similar to a search test, but test points are only set at the intersections of the check lines with the zone tolerances. The Check test is an efficient overall test of the relay with minimum testing time. This gives a quick verification of whether the specifications are met, particularly for routine tests.

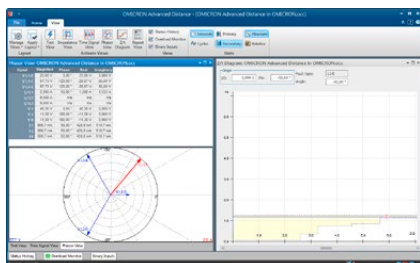

Adding test points and test lines to the tables is possible in a variety of ways. Parameters can be precisely defined by numerical inputs, or specified directly in the characteristic diagram. A magnetic cursor supports the choosing of meaningful values. Mouse commands, context menus and keyboard shortcuts facilitate data input.

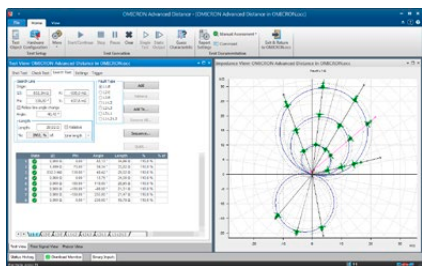

Advanced Distance (continued)

A test in Advanced Distance can have any combination of Shot, Search, or Check tests. At test execution, the whole test settings are executed sequentially. This versatile system offers a wide range of testing possibilities. Using this, it is easy to comply with a wide variety testing philosophies and regulations.

Relative test definitions

A powerful feature is the possibility to make test point definitions relative to the nominal characteristic of the distance relay (e.g. 90 % of zone 1, 110 % of zone 1, 90 % of zone 2,...). Test points are not entered in absolute R, X, Z, or angle values, but are referred to zone reaches and the line angle instead. This feature allows the creation of re-usable test templates, which adapt themselves to the actual relay settings.

Constant source impedance model

Besides the constant test current and constant test voltage models, Advanced Distance provides the constant source impedance test model which is useful in special cases where parameters such as SIR (Source Impedance Ratio) are important.

Load current

To verify special behavior of certain relays which occurs only when a pre-fault (load) current is present (e.g. accelerated tripping performance), a load current can be superimposed.

Testing multiple fault loops in one test module

Advanced Distance provides special support by performing the tests for multiple fault loops (L-N, L-L and L-L-L) within one test module. For all test modes (Shot, Search, Check) multiple tabs are provided with a separate test point table for every fault type. Test settings can either be entered fault-loop-specific or defined simultaneously for multiple fault types.

Distance Characteristic Guesser

If the nominal characteristic of a relay should be unknown or the actual characteristic shape is to be documented, a guesser function allows the automatic generation of an approximated characteristic based on the results of a Search and/or Shot test. The calculated characteristic can be saved and further used as the relay's nominal characteristic.

Multi-windows user interface

The user interface can be configured individually, using the following elements:

Test View

This view holds the test point tables for the Shot, Search, and Check tests and the impedance plane. Test definitions are made in this view. During and after the test execution, this view displays the results numerically in the tables and graphically in the impedance plane.

Z/t Diagram

This view shows the graded trip time curve over the impedance along a certain line. The actual line is determined in the impedance plane or by a selection in the test tables. It is also possible to define test points and to view the assessments in the diagram.

Phasor diagram

The phasor diagram shows the phasors of the voltages and currents. The corresponding table with the numerical values also lists the values for the symmetrical components.

Time Signal View

After a completed shot the voltages, currents, and binary signals are shown in this view. This is useful to perform more detailed investigations (e.g. time measurements using cursors).

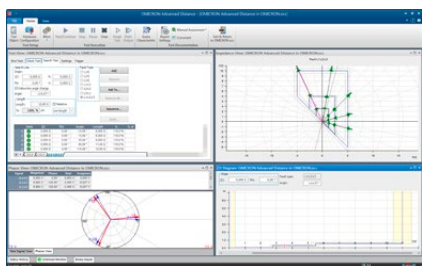

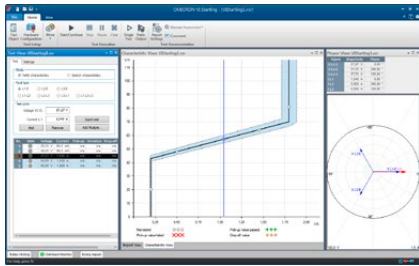

VI Starting

Essential Standard Enhanced Complete

VI Starting tests the voltage dependent overcurrent starting characteristic used in many distance relays. Additionally, it is a perfect tool for many tests on overcurrent and undervoltage functions. For any specified test point, it detects the pick-up value, the drop-off value, and the ratio.

Benefits

- > Automatic finding of characteristics
- > Automatic testing according to specified characteristics
- > Automatic determination of pick-up and drop-off values
- > Separate characteristics for phase-to-ground and phase-to-phase starting
- > Intuitive operation with graphical representation of the test
- > Clear representation of results in tabular and graphical form

Features

- > Easy fault specification with fault type and fault quantities
- > Generation of realistic test quantities with models for phase-to-ground, two-phase and three-phase faults
- > Phasor diagram with additional numeric display of the test quantities

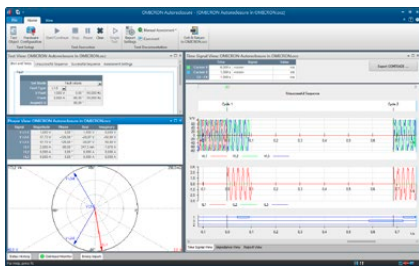

Autoreclosure

Essential Standard Enhanced Complete

Configuration of the test sequences for the autoreclosure (AR) function of protection relays is both effective and time saving. Autoreclosure automatically sets up test conditions for successful and unsuccessful sequences. Essential criteria, like the three-phase final trip at the end of an unsuccessful sequence are automatically evaluated as well.

Overcurrent, distance, or line differential relays with autoreclosure function can be tested. The faults are specified by entering the fault type and fault quantities. This is supported by the integrated Fault Calculator which calculates the output voltages and currents for the different fault types. For testing the autoreclosure function of distance protection, the fault can be specified in the impedance plane.

The test sequence is displayed over time and a list of events with assessments is reported.

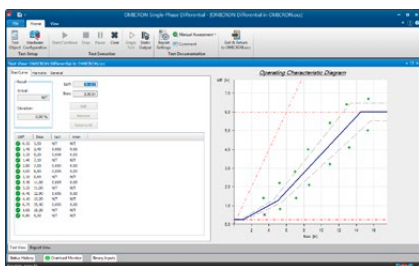

Single-Phase Differential

Essential Standard Enhanced Complete

Single-Phase Differential provides a compact testing solution for transformer, line, generator, and busbar differential protection relays. It performs single-phase tests of the operating characteristic (pick-up value, slope test) and the inrush blocking function (harmonic restraint test).

Variable tap settings, as for some older electromechanical relays (e.g. Westinghouse HU, or GE BDD) can be addressed. For the operating characteristic test, test points are defined in the Idiff/Ibias plane. A graphic user interface makes the test definition easy.

Single-Phase Differential also tests the harmonic restraint function. For this function, the test points are determined by the differential current and the percentage of the superimposed harmonic. The test currents belonging to the test points are injected into the relay and the reaction of the relay is assessed.

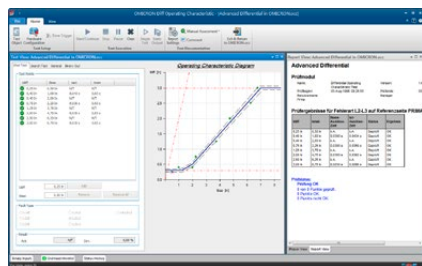

Advanced Differential

Advanced Differential is a set of test modules which form a complete testing solution for differential schemes. It is particularly suitable for transformer differential schemes with up to three windings and up to nine currents to be injected.¹

Extensive modeling of the protected object (e.g. power transformer), the secondary equipment (CTs, CT connection) and the relay characteristics provides the data for the calculations required to facilitate testing. The automatic calculation of the test currents eliminates the most time consuming and error-prone manual tasks. Testing the correct operation of the relay becomes simple, time saving, and cost efficient.

This test solution provides:

- > Testing with all fault types (L-N, L-L, L-L-L)
- > Shot tests at pre-defined test points or search tests
- > All shots synchronizable to GPS or IRIG-B for end-to-end testing (e.g. line differential protection)
- > Evaluation and assessment of results against nominal characteristics and tolerances
- > Report generation including graphical representation of the results in the characteristic diagrams
- > No blocking of voltage related functions required (important for testing of multifunctional relays)

For transformers, automatic calculation of currents to be injected are based on:

- > Transformer data (nominal data, vector group)
- > CT ratios and connections
- > Fault type
- > Fault/supply side (primary, secondary, etc.)
- > Load current
- > Magnitude and phase correction

For the protective relay, the assessment of the measured values is based on:

- > Operating characteristic
- > Bias calculation
- > Zero sequence elimination

If a suitable combination of a CMC and an additional amplifier unit is used, the modules can control up to nine currents for comfortable testing of three-winding transformer protection.

For non-transformer applications, such as testing generator differential protection, the current calculations are done without the transformer model.

Details of the four test modules in Advanced Differential:

Diff Configuration

This module simulates through-faults to verify that the protection is stable for faults outside the protected zone. Since investigation of the stability may require the observation of multiple measurements, the module gives the tester the option to check the readings before proceeding with the test. The actual values read from the relay under the fault conditions (operating or restraint currents of the different phases) can be entered in the report for full documentation.

Diff Configuration tests:

- > Secondary wiring and interposing transformers (electromechanical and numerical relays)
- > Correct parameter setting of digital relays (specification of protected object)
- > Zero-sequence elimination

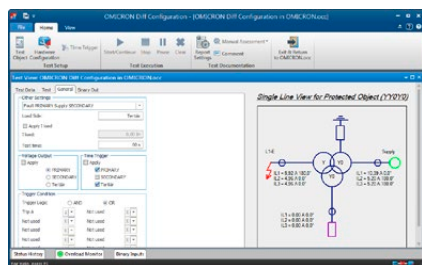

¹ To make full use of the typical applications of Advanced Differential a CMC test system providing more than three current outputs is required.

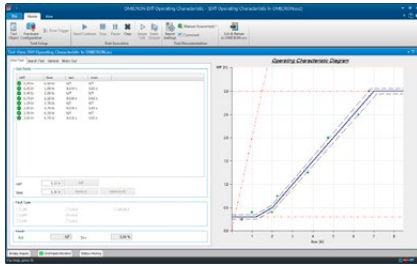

Diff Operating Characteristic

Diff Operating Characteristic module tests whether the operating characteristic of the relay distinguishes correctly between internal and external faults.

The currents injected into the relay are calculated from I_{diff}/I_{bias} value pairs specified in the I_{diff}/I_{bias} plane. This relates directly to how manufacturers commonly specify the operating characteristic. The correct reaction of the relay, either trip or no trip, is assessed against the specified characteristic.

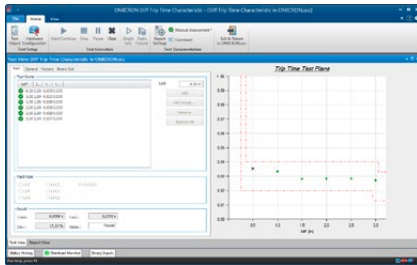

Diff Trip Time Characteristic

This module tests the dependency of the trip time from the magnitude of the differential current.

Diff Trip Time Characteristic measures tripping times at specified differential currents. The actual test currents for the specified differential currents are automatically calculated. The test points are defined in the trip time characteristic diagram and the measurements are assessed against this characteristic.

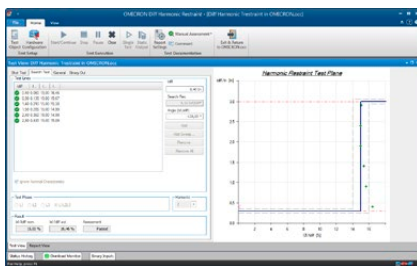

Diff Harmonic Restraint

Diff Harmonic Restraint tests blocking functions based on harmonics such as inrush, CT saturation or overexcitation. The test points are defined in the harmonic restraint characteristic diagram, where the differential current is drawn over the harmonic content of the test current.

For simulating different inrush conditions, the initial phase shift between fundamental and harmonics can be specified.

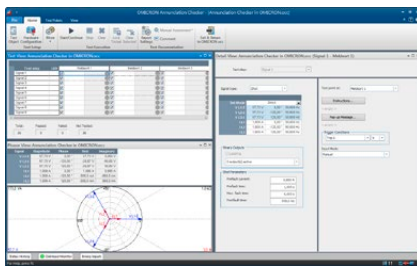

Annunciation Checker

Essential Standard Enhanced Complete

Today's protection devices emit dozens of different status signals or measured analog values. Each signal can be displayed at various locations.

Annunciation Checker helps the commissioning engineer to verify that the allocation of each message to its expected location (marshalling) and the wiring has been done correctly. A test specification can be created prior to the test and can also be flexibly adapted while a test runs. The test specification is done in a signal/location grid.

Signals stimulate a protective device and are generated as shots or steady states. The test engineer can navigate through the test grid in any order (e.g. signal by signal or location by location). Each cell of the grid corresponds to a signal indicator at a certain location. The response of the indicator is evaluated automatically. The test results are summarized in a tabular test report.

Annunciation Checker is a typical commissioning tool used in conjunction with the central SCADA operator. It provides a work plan (points list) and a good source of documentation.

Power / Advanced Power

The test modules Power and Advanced Power are used wherever the visualization and assessment in the complex P-Q plane is helpful or essential. Testing applications include load shedding based on power or frequency criteria, stability functions like Q-V protection, power swing blocking, and rotating machinery protection.

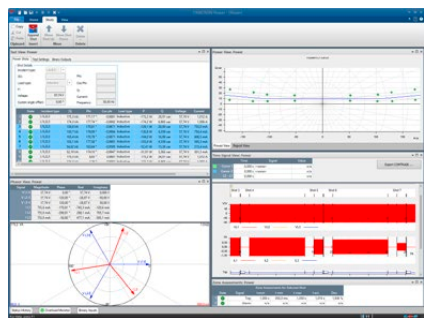

Power

Essential Standard Enhanced Complete

The module Power supports basic shot testing and assessment in the P-Q / S- ϕ domain.

- > Complex power view P-Q
- > Absolute primary, secondary, or, relative power data
- > P-Q axis switching in views
- > Complex power zones/elements
- > Additional voltage and current threshold for automatic test assessment
- > Constant voltage or constant current mode
- > Binary output control for pre-incident, incident and reset states
- > Improved tolerance handling with absolute and relative magnitude tolerance plus angle tolerance
- > Shots defined as P-Q or S- ϕ or S-cos ϕ (ind/cap)

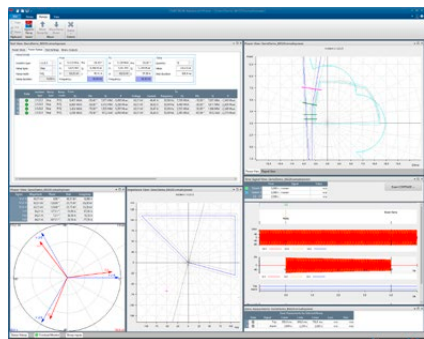

Advanced Power

Essential Standard Enhanced Complete

In addition to all of the features found in the module Power, Advanced Power also offers dynamic and more sophisticated testing features such as smooth ramps and trajectories through characteristics, mapping of impedance zones into the P-Q plane, frequency variation and more.

- > Complex power ramps
 - > Contiguous (gap-free) ramp segments for power swing trajectories, etc.
 - > Linear P-Q ramps (along a straight line in the P-Q plane)
 - > Linear S- ϕ ramps (along an arc defined in the P-Q plane)
 - > Smooth or step ramps with time-linear change in P, Q, S or ϕ (1 ms resolution)
 - > Ramp assessment according to timing and/or thresholds and/or according to defined protection zone boundaries
 - > Linear frequency change supported (e.g. generator acceleration / deceleration)
- > Impedance (R-X) view
 - > Test object characteristics defined in the R-X plane, such as loss of field and distance protection, may be transformed into and shown in the P-Q power view
 - > Impedance transformation depending on operating mode (const. voltage or const. current)
- > Frequency setting per test state
- > Test repetition with statistical analysis
- > Mirrored/scaled currents for a second current triple to avoid pick-up of differential elements

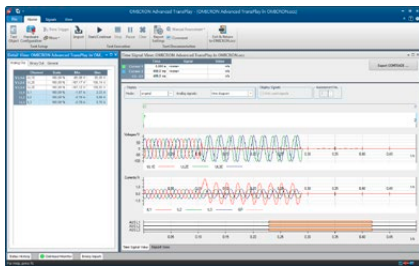

Advanced TransPlay

Advanced TransPlay enables the CMC system to test with transient signals. Transient signal data, obtained from fault recorders, CMC test sets with EnerLyzer option (CMC 356, CMC 430 or CMC 256plus), or network simulation programs, can be loaded and viewed, processed, and replayed with Advanced TransPlay. The reaction of the protection device tested with such signals is recorded and assessed, and a test report is generated.

- This makes it an ideal tool for
- > troubleshooting with fault records
 - > relay evaluation with transient files (e.g. EMTP calculations)
 - > end-to-end testing

Advanced TransPlay supports the following file formats:
 IEEE COMTRADE (IEEE C37.111-1991/1999 and 2013) respectively IEC 60255-24, PL4 and CSV.

After a transient file has been loaded, the part of the signal to be replayed is selected by markers. It is possible to repeat parts of the signal, e.g. for extending the pre-fault time. Markers can be set in order to point out significant events in the recording, such as fault inception, starting, tripping, etc.. These markers are the basis for time measurements.

Besides playing back voltage and current signals, Advanced TransPlay can also replay the binary signals in a fault recording via the CMC's binary outputs. Additional binary signals (e.g. carrier send/received signals from communication-based schemes) can be added. During playback, the selected voltage, current, and binary signals are applied to the protection device. Playback can be synchronized via GPS, IRIG-B protocol or by a time pulse applied to a binary input.

The reaction of the protection device is measured and assessed on the basis of time measurements. Absolute and relative time measurements are possible:

- > Absolute time measurements determine for instance starting or trip times of the relay during signal playback
- > Relative measurements compare the relay's reaction during playback to its behavior stored in the recording (reference)

This makes it possible to investigate

- > if the relay scatters (differences between recording and actual behavior during playback)
- > how a different protection device operates under the same conditions

Advanced TransPlay provides a repetition mode; the individual results for each repetition, as well as average and standard deviation values (statistic functions), are displayed.

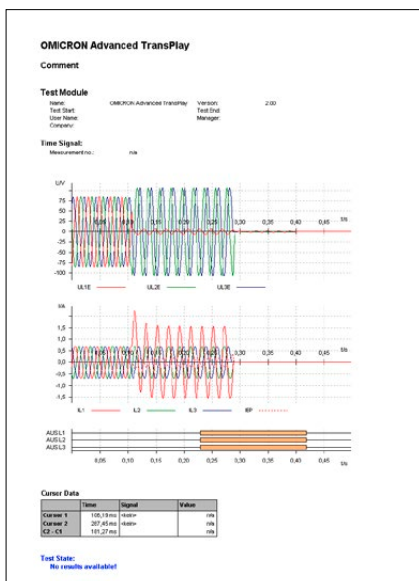

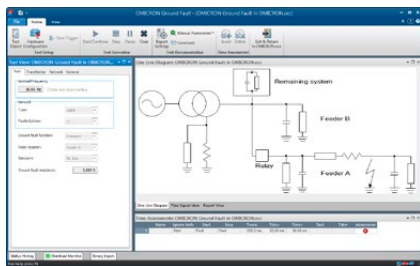

Transient Ground Fault

Essential Standard Enhanced Complete

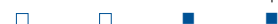

Transient Ground Fault tests the directional decision of transient or steady-state ground fault relays in grids with isolated or compensated grounding. It produces the transient voltages and currents during a ground fault from a fault simulation with a pre-defined network model. The network simulation provides testing with realistic current and voltage waveforms. The model simulates a spur line. The calculated quantities are determined by the parameters of the line and the feeding network.

For testing the directional decision of steady-state ground fault relays, the steady-state fault quantities after the decay of the transient process can be continuously output. To allow for the testing of relays in both the forward and the reverse direction, the fault can be applied on different feeders.

The module performs an automatic assessment of the measured data based on the user's specific application. The output signals are shown in a separate view. They can also be displayed or printed with the automatically generated test report. The test execution can be manually initiated or synchronized by using an external trigger signal.

The module is of particular assistance when

- > setting the relay
- > checking the relay's directional characteristic

Both three-phase systems and two-phase systems (e.g. for railway applications) can be simulated.

For a comprehensive simulation of ground faults, we recommend to use RelaySimTest (see page 30). A Transient Ground Fault license is included in a RelaySimTest license.

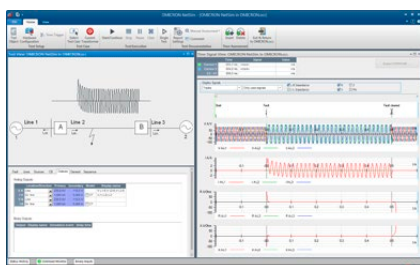

NetSim

Essential Standard Enhanced Complete



NetSim enables users of Test Universe to test the behavior of protective devices in the event of a realistic fault by means of transient signals. Standard network configurations with simple parameter settings allow fast, rudimentary simulations with a limited set of test cases.

Application examples:

- > Relay testing under real-life conditions
- > Evaluation of relay settings for difficult protection applications
- > Testing of advanced protection algorithms
- > Faults on single and parallel lines (including mutual coupling), stub lines, three terminal lines
- > End-to-end testing with GPS or IRIG-B time synchronization
- > Network oscillation/power swing (synchronous and asynchronous)
- > Testing of differential protection including CT saturation

Further functions:

- > Automatic repetition of tests with varying parameters
- > Impedance view including distance zones
- > Additional COMTRADE export of simulated waveforms

For comprehensive system-based testing, we recommend to use RelaySimTest (see page 30). A NetSim license is included in a RelaySimTest license.

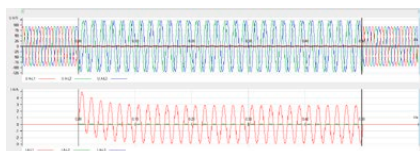

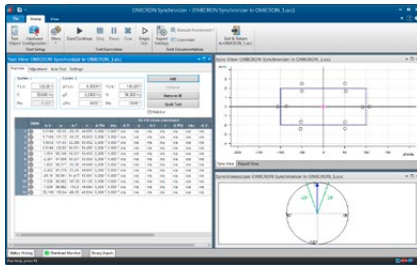

Synchronizer

Synchronizer simulates two systems to be synchronized: System 1 representing the mains is fixed in magnitude and frequency, system 2 is controlled in magnitude and frequency and represents the generator or system to be synchronized.

Using the module in single-phase to single-phase mode (each system represented by one voltage) is possible with any CMC test set. With a CMC 356, CMC 353, or CMC 256plus, three-phase to single-phase synchronization is possible, using the additional fourth voltage phase to represent the second system. With a CMC 430, or the additional use of the voltage channels of a CMS 356, even a three-phase to three-phase synchronization is possible.

The software automatically detects the circuit breaker closing command from the synchronizing device or synchro-check relay and, taking the CB closing time into account, evaluates if the synchronization takes place inside the synchronizing window. The control of the second output is variable following different test modes. The frequency and magnitude can be changed linearly depending on the ramping time constants of the generator.

For synchronizing devices with automatic adjustment functions, the adjustment control commands ($f\uparrow$, $f\downarrow$, $V\uparrow$, $V\downarrow$) may be used to control the second voltage output. To simulate the real system as closely as possible, dynamic generator models are available. The binary contact sequences of the adjustment commands, and the changes of voltage and frequency, can be monitored graphically in order to follow the progress of the synchronization.

An implemented synchronoscope displays the rotating voltage vector of system 2 respectively the moment of synchronization.

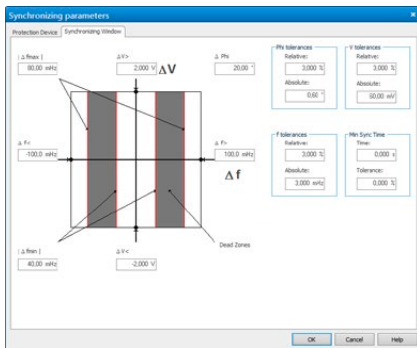

Meter

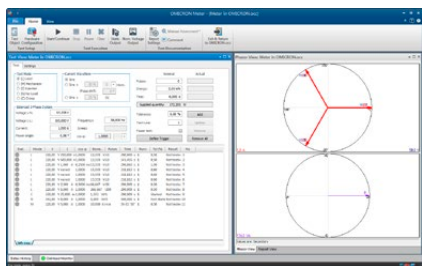

Until now, the usual method for testing of energy meters has been to use a stabilized, but not very accurate, power source, in combination with a high-precision reference meter. OMICRON's approach significantly simplifies meter testing. By using state-of-the-art hardware technology, OMICRON provides test sets that are so accurate and stable, that the signal source itself becomes the reference and make a reference meter unnecessary.

The CMC test set – ideally a CMC 256plus or CMC 430 with its high-precision voltage and current outputs – not only provides the test signals, but also has inputs for the meter pulses allowing closed-loop testing. To this end, optical scanning heads for capturing pulses emitted by the meters (infrared LEDs) are available.

Meter allows for manual or automated testing of energy meters. Each line of the test table represents a test point, which can be run in one of the following modes:

- > Load test: Accuracy of measurement unit (time power method)
- > Mechanism test: Accuracy of entire meter including display
- > Gated Mechanism test: Testing internal meter registers
- > Injection test: Quick check (wiring, sense of rotation)
- > No-load test: No start-up at zero load
- > Creep test: Start-up at low loads

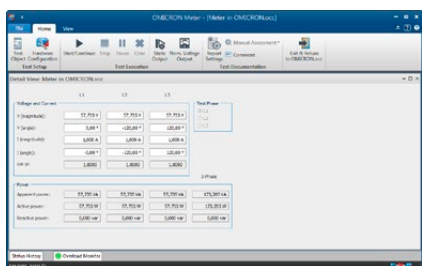

In the columns of the table the individual test parameters, the set assessment criteria (tolerance, nominal behavior), and the result of the test, including the assessment (passed or failed) are displayed. For multifunctional meters, or meters with two directions of rotation, a table per test function is available (multiple tabs). Test lines can be repeated several times. In this case the standard deviation is displayed together with the meter error, which allows conclusions of the correctness of the test itself. Single test steps (e.g. those assessed as failed) can be repeated after a test run is finished, without the need for repeating the whole test.

The test quantities are displayed graphically by means of the voltage, current and power phasor diagrams. The test can be performed with any balanced or unbalanced load for single-phase meters (or a single measurement element of a 3-phase meter), 3-wire meters, and 4-wire meters.

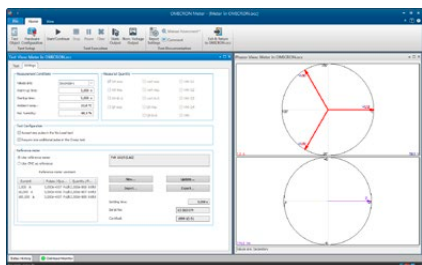

For testing the behavior of meters with harmonics or DC components, the following current signal waveforms are available: Sine, Sine + Harmonics, Sine + DC

In a detail view, all parameters can be specified independently for each phase. Apparent, active and reactive power is indicated for each phase and the whole rotary system. Testing of the following meter functions is supported:

- > Wh importing/exporting
- > VARh importing/exporting
- > VAh
- > I²h and V²h (load/no-load losses of transformers)
- > Qh (quantity hour)

The results of an automatic test are clearly summed up in a tabular test report (one line per test point). For a manual test, generating any test quantities, without defining a complete test procedure, can quickly check the correct functioning of meters. In this mode the constant of a meter can also be determined, in case it is not known or if there are doubts about it.

Also operation in conjunction with an external reference meter is possible: When testing with a reference meter, the CMC is used as a current and voltage source. During a load test, the pulses of the meter under test as well as those of the reference meter are registered. The latter form the reference for error calculation.

Furthermore, testing against a 0.02 or 0.01 % reference before a test is run, using the same test points, can eliminate errors of the CMC by loading correction values.

Transducer

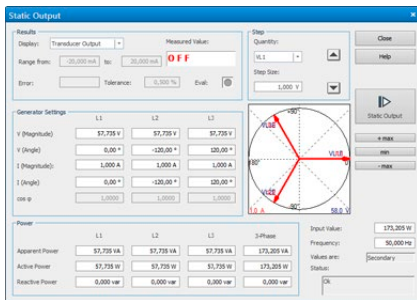
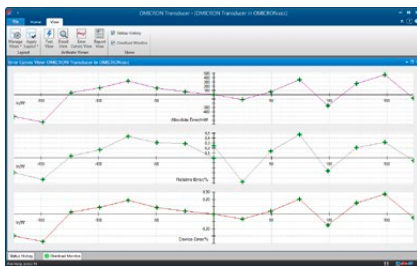
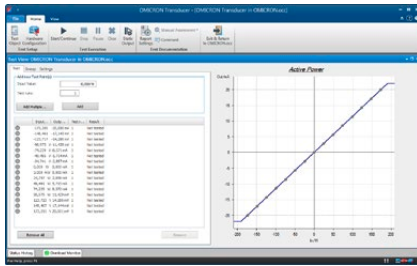

Transducer enables a CMC¹ for manual or automatic testing of any measurement function of transducers, such as:

- > Real power (single- or three-phase)
- > Reactive power (single- or three-phase)
- > Apparent power (single- or three-phase)
- > Frequency
- > Current
- > Voltage (phase-to-ground, phase-to-phase)
- > $\cos \phi$
- > Phase angle (V-I, V-V, I-I)
- > DC quantities (current, voltage, power)
- > Signed average of currents

The module supports testing of the following types of characteristics:

- > Linear
- > Compound
- > Quadratic
- > Symmetrical or non-symmetrical

The "manual test" mode is used, if a measurement transducer is to be re-adjusted. Every desired input quantity can be generated for the transducer. Furthermore, it is easy to switch between significant points of a characteristic, where the error of the transducer is shown at a certain input value.

An automatic test includes the sequential output of a pre-defined test point table, as well as the documentation and assessment of the results. Here, the test points represent the input value of the measurement transducer. In addition, the behavior at changing input voltage or frequency can be performed as an option.

The error of a transducer is determined by comparing the theoretical signal and the actually measured output signal. Relative, absolute and device errors are derived and graphically displayed in a diagram. If multiple test runs are performed, the average error is indicated.

Single test points or test sequences can be added to the test point table. The table includes: input value, output value, device error and assessment (test passed or failed).

During the automatic test run all test points are processed in a sequence. The transfer characteristic including all test points (passed or failed) is displayed graphically. If remote displays should be checked during the test run, the test can also be controlled manually.

Measuring transducers for three-wire (Aaron circuit) as well as four-wire systems can be tested. Currents as well as voltages can be generated as pure sine signals or superimposed with harmonics or DC components. New generation transducers often no longer have classical mA or VDC output. They rather transmit the measured data via transfer protocol or/and visualize values at a display. The mode "open loop testing" supports testing this type of transducer.

¹ CMC 256plus, CMC 430, or CMC 356 with ELT-1 hardware option. Used CMC 356 test sets without ELT-1 can be upgraded.

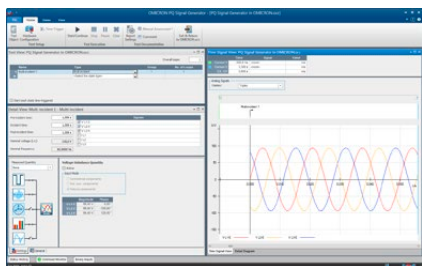

PQ Signal Generator

The need to verify the functionality and accuracy of power quality meters/analyzers requires appropriate calibration equipment. PQ Signal Generator turns a CMC test set – ideally a CMC 256plus or CMC 430 with its high-precision voltage and current outputs – into a calibration tool that generates all kinds of power quality phenomena according to IEC 61000-4-30:

- > Power frequency
- > Power supply voltage
- > Flicker
- > Dips & Swells
- > Voltage interruption
- > Transient voltages
- > Voltage unbalance
- > Harmonics
- > Interharmonics
- > Rapid voltage changes

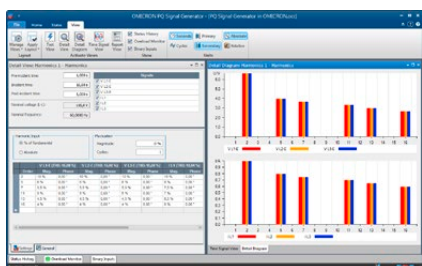

PQ Signal Generator features a powerful and easy to use interface, that also allows to combine different power quality phenomena for comprehensive testing.

Based on tables 1 and 2 of the IEC 61000-4-15 standard, the module provides a selection of paired values for flicker frequencies and magnitudes. Each of these pairs results in a pre-determined Pst-value which can be used for the calibration of flicker meters. Flicker magnitude and flicker frequency starting from 1 mHz can be set individually by the user.

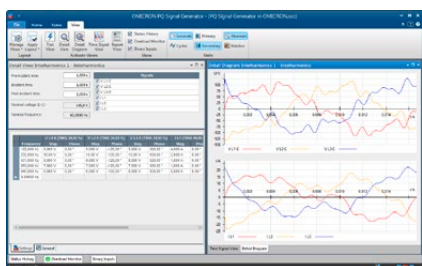

Depending on the type of CMC test set used, voltage and current signals with superimposed harmonics (up to the 60th harmonic at 50 Hz or 50th harmonic at 60 Hz) and interharmonics up to 3 kHz can be generated. Harmonic magnitudes can be entered either in absolute values or in percentages of the fundamental value. For advanced applications, even fluctuating harmonics can be generated. If only one interharmonic is used the frequency resolution for this is 1 mHz, moreover any combination of interharmonics with whole-number Hertz values can be set up.

An example of the module's versatility is the generation of cyclic notches. The notch depth and the angle of occurrence can be adjusted independently; the minimum gap-width for notches is 300 μ s. This function can provide the possibility to simulate the system perturbation of a thyristor-controlled motor.

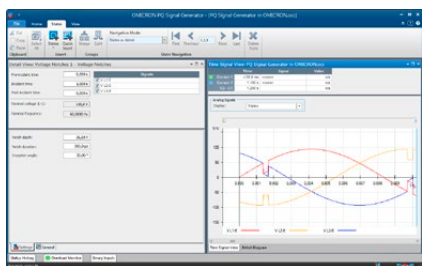

PQ Signal Generator allows the creation of comprehensive test sequences. Test steps can be grouped and run repeatedly in a user-definable number of loops. If the test object provides a binary output, it can be used for automatic assessment of the test results. If no alarm contact is available, manual assessment can also be performed.

PQ Signal Generator enables the CMC test set to support testing in accordance with IEC 62586. This standard defines the test methods to verify compliance with IEC 61000-4. An extensive testing library is available to provide support in performing most type tests required by these standards.

In the past, the testing of PQ related equipment required a high level of investment in separate testing equipment. With PQ Signal Generator, the testing of PQ analyzers can be performed with the CMC test set quickly and easily.

Measurement package

The modules Meter, Transducer, and PQ Signal Generator can also be ordered as a package (add-on to Test Universe packages, see page 9):

- > Measurement Equipment Testing (P0000411)

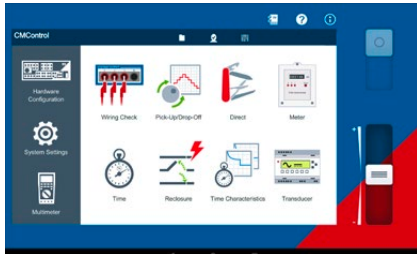

CMControl P – Easy manual testing

CMControl P is a control option for CMC test sets which is specifically designed for easy manual testing of protection and measurement devices. It is available as an App for Windows PC or Android tablets and as a dedicated front panel control device. The included test tools with integrated fault models guarantee quick and convenient tests:

- > Wiring Check: is used to quickly verify the wiring and the measuring inputs of the device under test and also supports the use of the CPOL2 polarity checker
- > Pick Up/Drop Off: for checking thresholds of protective relays
- > Direct: all of the test set's outputs can be controlled individually
- > Meter: to calibrate electricity meters and to perform start-up and no-load tests
- > Time: trip times or other timings of a protective relay can be verified
- > Reclosure: the number of cycles and cycle times of a reclosure function can be checked
- > Time Characteristics: test relays with multiple timing stages or particular time characteristics
- > Transducer: to verify and automatically assess the accuracy of a transducer¹
- > Multimeter: the multifunctional inputs of CMC test sets can be used for analog measurement¹

CMControl P App

The CMControl P App runs on a standard Windows PC or Android tablet to control your CMC test set. A dedicated mini Wi-Fi USB adapter enables wireless control of CMC test sets.²

Download the free demo App:

- > for your Windows PC from the OMICRON Customer Portal
- > for your Android tablet from the Google Play™ Store

CMControl P front panel control

The robust front panel control device CMControl P is available in two sizes and can either be attached to the CMC test set or be used as a flexible handheld control. It offers a 7" touch screen and a magnetic rear for attaching to steel surfaces. Detailed technical specifications see page 51.

Ordering information

CMControl P can be ordered with a CMC test set either standalone or in combination with a Test Universe package. In the Standard, Enhanced, and Complete package, a license for CMControl P App is included (see page 9).



	CMControl P App	CMC ³ + CMControl P App	CMC ³ + CMControl P	CMControl P retrofit
CMC 356	P0000344	P0000805	P0000973	P0006256
CMC 256plus		P0000709	P0005868	
CMC 430		P0005881	-	-
CMC 353		P0000695	P0005871	P0006257
CMC 310		P0005873	P0005872	

If CMControl P is ordered with Test Universe along with a new CMC, refer to CMC ordering information on the corresponding product page on our website.

For more detailed information, please visit www.omicronenergy.com/cmcontrol-p or refer to the CMControl P product brochure.

¹ With CMC 256plus, CMC 430 or CMC 356 with ELT-1 hardware option

² Requires a CMC test set with NET-2 interface board. Wi-Fi is subjected to technical and legal constraints. For more information please contact your local OMICRON office or sales partner.

³ Without Test Universe

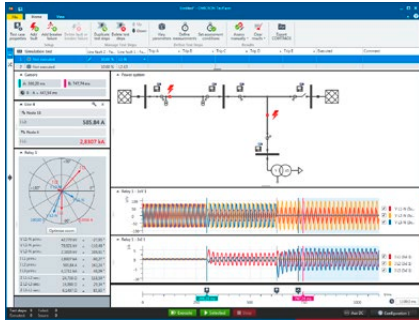

RelaySimTest – System-based protection testing

RelaySimTest is a software solution for system-based protection testing with OMICRON test equipment that takes a novel, future-oriented approach: the test is independent of relay type and relay manufacturer and the often very extensive parameter settings. Instead, it completely focuses on the correct behavior of the protection system. This is made possible by simulating realistic events in the power system.

Compared to conventional test methods (such as settings-based testing with Test Universe), RelaySimTest can detect errors in the settings, logic and design of the protection system much better. This allows testers to verify the correct behavior of their protection system faster and with a higher testing quality than ever before. Complementary to testing with Test Universe, RelaySimTest contributes to a more reliable power system.

Simple and flexible operation

Predefined test templates give you a quick and easy start in standard testing situations. Thanks to the flexible network editor, even complex power systems can be simulated. The correct behavior of the protection system can be easily checked in all scenarios by placing faults and circuit-breaker events. The calculated test signals can be analyzed in advance and then executed via the test device.

Remote testing

For example, testing a line protection is very simple: RelaySimTest automatically calculates the test signals and then starts its time-synchronized execution from one PC. The test equipment can be synchronized by a PTP Grandmaster Clock (e.g. CMGPS 588) or by a CMIRIG-B. Subsequently, all of the protection system's reactions are evaluated centrally. This not only makes execution faster and easier, but also aids you in troubleshooting. Test equipment can also be controlled from a PC at remote locations via an Internet connection.

Logic and scheme testing

The indispensable test of logic in protection systems usually involves a complex sequence of states triggered by trip and close commands. Thanks to the patented "Iterative Closed-Loop" method, RelaySimTest can automatically build the test sequence according to the trip and close commands. Testing, for example the coordination of an auto-reclose function in the system, becomes simple and transparent.

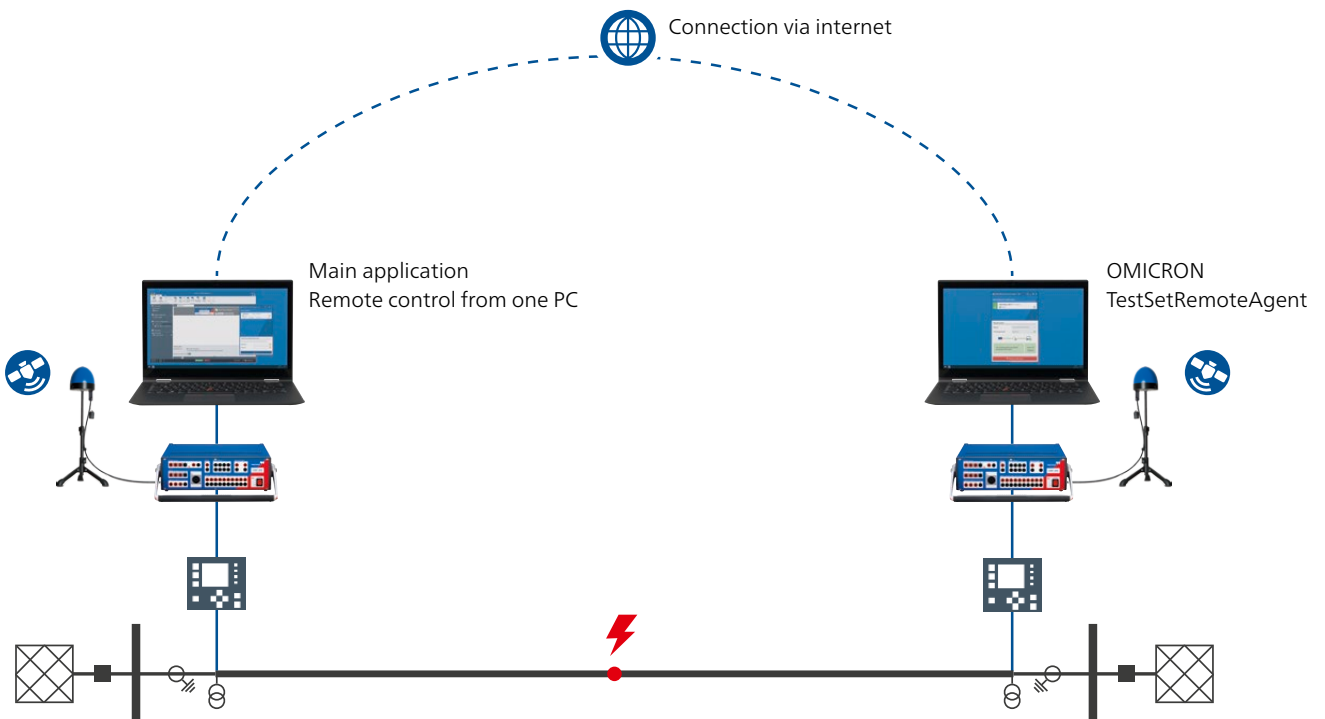

Application areas

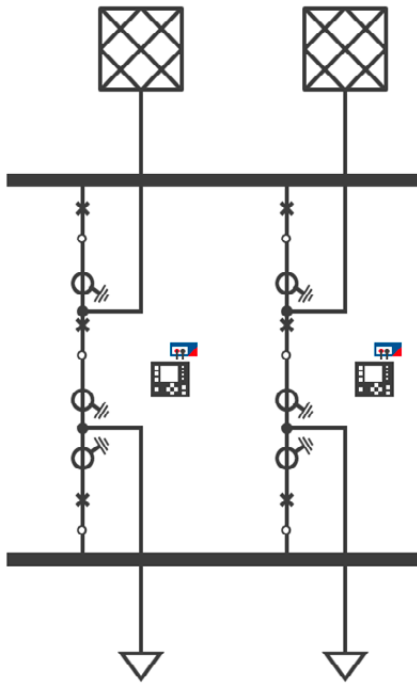

Example topology of a busbar

Substation

- > Busbar protection: Any type of busbar topology can be modeled. Simultaneous injection to any number of field units. Simulation of disconnecter position and faults on every node including dead-zone faults in the coupling field.
- > Breaker-and-a-half: Test with six current-inputs. No need to re-wire during the test. Check coordination of both relays e.g. for breaker-failure protection.
- > Insulated and compensated networks: Testing of the protection system for transient and intermittent earth faults and evolving faults.
- > Transformer differential protection: Simulation of 2- and 3-winding transformers, tap changer and phase shifter. This validates the configuration of transformer protection.

Transmission

- > Teleprotection and line differential: Test the protection including its communication channels. Control the test setup from one end without having to coordinate each test over the phone.
- > Auto-reclosing: Simple testing of auto-reclosing sequences independent of reclosing attempts and single or three pole tripping. Simultaneous coordination testing for multiple relays.
- > Three-terminal lines: Control each test set from three or more terminals on one end without having to coordinate each test on the phone.
- > Parallel lines with mutual coupling: Simulate mutual coupling between line segments as they occur in your real-world topology. Test for over- and under reach when parallel lines are in operation or grounded.
- > Power swing & out-of-step: Test the tripping or blocking of the protection during out-of-step and power-swing condition. Combine power swings with fault and breaker events.
- > Series-compensated lines: Test complex zone coordination on series compensated lines including their effect on time grading.

Distribution

- > Distribution Automation loop scheme: Inject to every single recloser control unit in the loop scheme simultaneously. Tests the full operation sequence from fault isolation to service restoration.
- > Reverse blocking schemes and selectivity testing

Lab and factory testing

- > Performance tests in accordance with IEC 60255-121
- > Pre-qualification of new relay types

Note: All test applications can be combined flexibly.

Supported test sets and accessories

- > CMC 356, CMC 353, CMC 256plus, CMC 430, CMC 850, ARCO 400
- > CMGPS 588 and CMIRIG-B (for time-synchronized injection)
- > Binary extension ISIO 200

Order No.	Delivery contents
P0006620	One license for RelaySimTest
P0006621	Package for distributed testing, including two licenses for RelaySimTest plus two CMGPS 588
P0006611	RelaySimTest license for ARCO 400, enables synchronized distributed scheme testing for recloser controls

A RelaySimTest license also includes the licenses for Transient Ground Fault and NetSim (see page 24).

For more detailed information, please visit www.omicronenergy.com/relaysimtest or refer to the RelaySimTest product brochure.

EnerLyzer / EnerLyzer Live, TransView

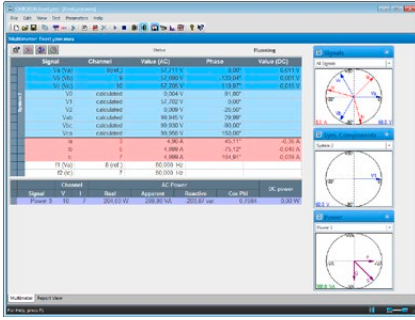

EnerLyzer / EnerLyzer Live transform the CMC test set into a multifunctional measuring, recording and analysis device. Each of its binary inputs can be configured as an analog measuring input and can then directly measure voltages as high as 600 VRMS. Currents are acquired via the measuring shunts¹ or current clamps. The CMC test set can be used for conventional testing and simultaneously for measuring with EnerLyzer / EnerLyzer Live.

Broad range of applications

EnerLyzer / EnerLyzer Live offer a wide range of views and analysis tools: both direct and derived measurands can be displayed as numerical values (multimeter view) or in phasor diagrams. The harmonic analysis facilitates the quick and easy examination of the harmonic content and shows the total harmonic distortion (THD) value. The CMC can also be used as a multichannel transient recorder. TransView (see page 33) is included to enable a more detailed analysis of the transient values recorded in this way. These tools allow faults to be localized quickly and easily and the corresponding system parameters to be evaluated.

Typical applications:

- > Troubleshooting during commissioning or maintenance testing of protective devices
- > Recording of transients during switching operations
- > Analysis of transformer inrush events (for example, analysis of harmonics to adjust the blocking)
- > Analysis of starting characteristics of motors (current/voltage curves, determining start-up times)
- > Measurement and analysis during generator synchronization with synchro-check function
- > Diagnosis of timing characteristics of circuit breakers and their auxiliary contacts
- > Analysis of system perturbations and power quality (for example, THD, harmonics)
- > General measurement functions (for example, plausibility checks for voltages, currents, power)

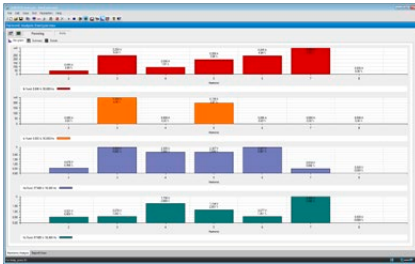

Essential Standard Enhanced Complete

EnerLyzer

EnerLyzer (P0006601) is available for CMC 256plus and CMC 356² test sets.

Trend recording

Important quantities (for example, RMS of currents and voltages, frequency or power) are displayed in a chart as a function of time. Selecting longer measuring rates enables an analysis to be carried out over longer periods (for example, weeks, if the measuring rate is in seconds). The recorded data can be exported in CSV format for further processing.

Transient recorder

The maximum sampling frequency is 28 kHz, while the maximum recording duration depends on the number of channels being used and the selected sampling frequency (one channel at 3 kHz produces a recording time of more than five minutes). The recordings are stored in COMTRADE file format (C37.111-1991/1999) and can be analyzed in TransView.

¹ The scope of delivery of EnerLyzer / EnerLyzer Live includes three C-Shunt 1 and three C-Shunt 10 (see page 59).

² For CMC 356: Optional ELT-1 hardware required. Used CMC 356 test sets without ELT-1 can be upgraded.

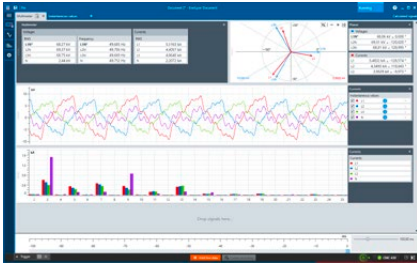

EnerLyzer Live

Essential Standard Enhanced Complete

EnerLyzer Live (P0006593) is a universal measurement tool tailored specifically to the CMC 430.

Hybrid measurement functionality

EnerLyzer Live provides comprehensive functionality for carrying out measurements in digital substations. Sampled Values (IEC 61850-9-2) and conventional signals can be measured simultaneously and displayed together along a common time line.

Oscilloscope view and real-time trend analysis

Instantaneous values and trend curves are displayed in real time; any faults are immediately apparent. Measured quantities are displayed clearly in a number of ways (numerical values, trend curves or as phasor diagrams) and in a range of views. The measurement view can be customized as required.

Transient recording and analysis

The maximum sampling frequency is 40 kHz. This sampling frequency permits recordings of up to 20 minutes duration. These recordings can then be analyzed immediately in EnerLyzer Live. Simple or complex trigger conditions can be defined for the recording of faults or inrush phenomena in the electrical power system. The recorded data can be exported in CSV or COMTRADE format (C37.111-1991/1999 and 2013), if a more detailed investigation needs to be carried out.

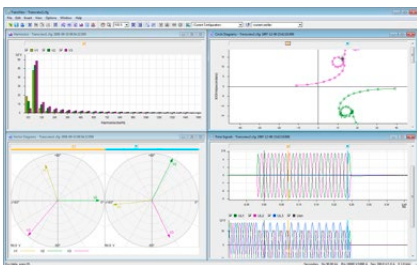

TransView

Essential Standard Enhanced Complete

TransView is used to visualize and analyze analog and binary signals that have been recorded by the transient recorders (relay-internal recording, CMC test set with optional EnerLyzer / EnerLyzer Live, DANEO 400, fault recorder). The software processes the recorded data graphically and uses the measurement data to compute additional electrical power system quantities, such as impedances, power vectors, RMS, etc.

The values are displayed either as primary or secondary values in a range of views:

- > Time signals: Analog and binary signals are displayed as a function of time. Analog quantities can be displayed as instantaneous or RMS values.
- > Phasor diagrams: This view shows the measured and calculated quantities (for example, symmetric components) as complex vectors at defined points in time.
- > Locus diagrams: This view shows complex quantities in the form of locus diagrams. Impedance locus diagrams can be shown together with the trip zones of distance relays. Zone settings can be imported using the XRIO format.
- > Harmonics: This view shows the RMS of the harmonics of selected quantities as bar graphs. The harmonics are determined using a full-cycle DFT (Discrete Fourier Transformation).
- > Value table: The Table view shows the values of several signals at the marker positions. The signals are arranged as rows, where the individual columns contain the respective values.

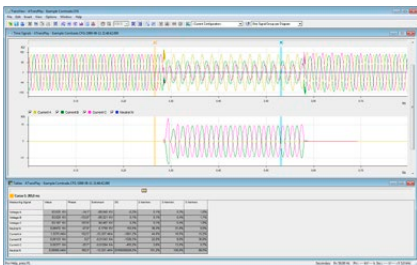

TransView enables a number of recordings to be analyzed simultaneously, for example, those from both ends of a line. TransView supports data in COMTRADE format (IEEE C37.111-1991/1999 and 2013).

Note: TransView can be used

- > As part of EnerLyzer (no separate order necessary)
- > As part of Test Universe (without EnerLyzer) [P0006837]
- > As a stand-alone application without CMC or Test Universe [P0006602]

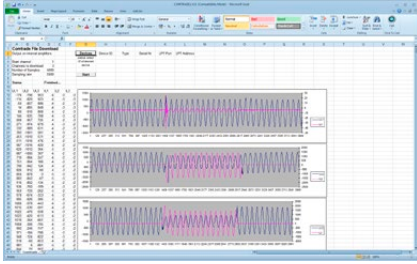

CMEngine – Programming interface

CMEngine (P0006842) is a programming interface with open-source documentation. It provides access to the entire functionality of the CMC test set hardware and enables programs to be written to meet customer-specific requirements. Amongst other things, CMC test sets and their associated amplifiers and accessories can be integrated into a dedicated test environment and controlled by whichever applications you are running.

Programs can be written in one of the standard programming languages, such as C/C++, Visual Basic, C# or LabView. With CMEngine, the CMC test set can also be controlled by standard programs that support Microsoft Automation (for example, Microsoft Excel).

Typical applications include factory acceptance testing by protection equipment manufacturers. In fixed test installations, where test objects are subjected not only to electrical but also to thermal or mechanical tests, a volume production's test engineer benefits from the ability to use the same user interface for all applications. Using CMEngine also increases the degree of automation and hence the level of efficiency.

Advantages

- > Interface for interacting with CMC test sets
- > Direct access to all hardware functionality
- > Programming with standard programming languages or a batch application (CMEngine CLI)
- > Integration of CMC test sets to a proprietary testing environment
- > Creation of special waveforms

OMICRON offers protection and SCADA engineers a set of advanced solutions for testing in IEC 61850 environments. The individual tools complement one another and cover a wide range of requirements: while Test Universe and RelaySimTest are used specifically for protection testing, further products mentioned in this section, such as StationScout, IEDScout and DANE0 400, focus on communication. They allow users to observe, track and analyze the behavior of data packets in the communication network and the data flow for protection, automation and control.

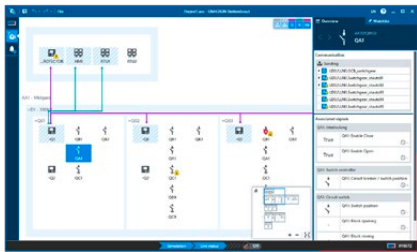
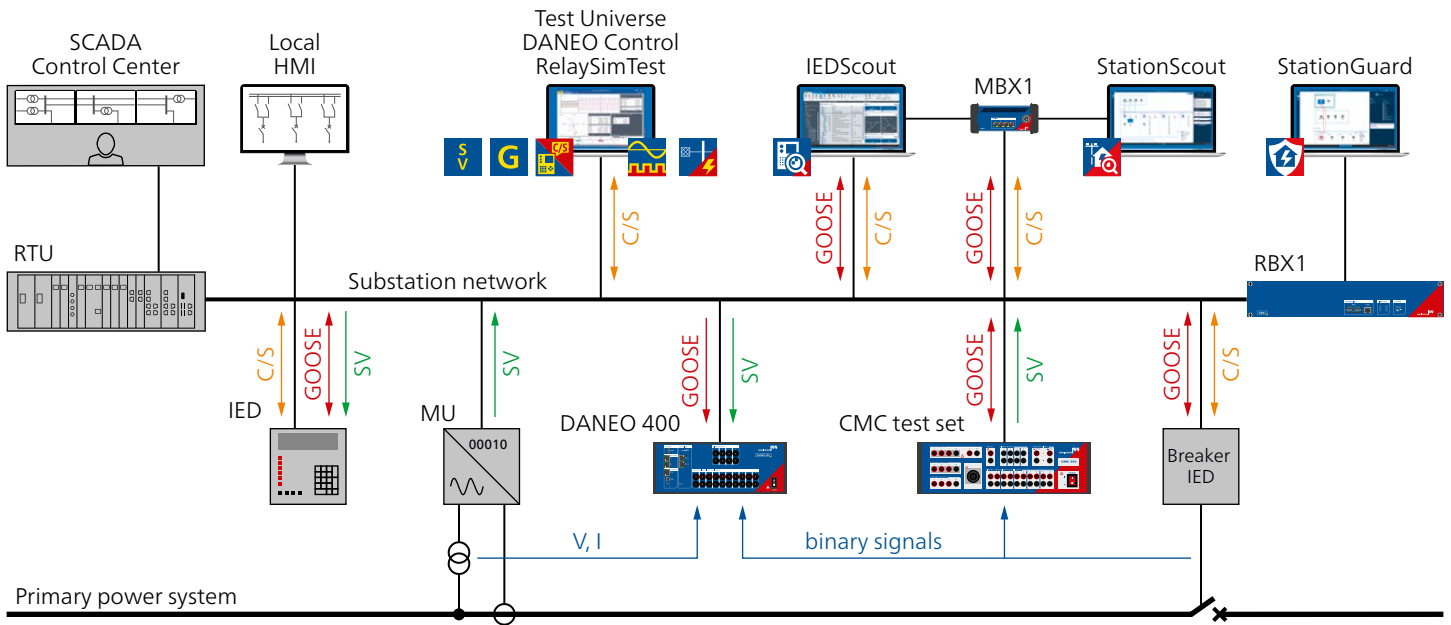

StationScout

Testing automation, control, and SCADA communication in an IEC 61850 Substation Automation System (SAS) is as time-consuming as testing the protection – or often even more. StationScout simplifies the testing and reduces the required effort significantly. Running on the new digital substation platform MBX1, StationScout visualizes and analyzes the communication in an SAS in an unprecedented way. The topology is determined from the engineering data in SCL (System Configuration Language) and displayed intuitively for the SCADA engineer. StationScout supports designers and testing engineers throughout the entire life cycle of an SAS with a combination of simulation and testing functions.

Order No.	Delivery contents
P0006530	StationScout Smart Overview License StationScout software for manual testing of Substation Automation Systems
P0006531	StationScout Commissioning License StationScout software for testing and commissioning of Substation Automation Systems

StationScout can be used with the cyber-secure platforms MBX1 or RBX1. For more detailed information, please visit www.omicronenergy.com/stationscout or refer to the StationScout product brochure.

IEC 61850 Testing & Cybersecurity

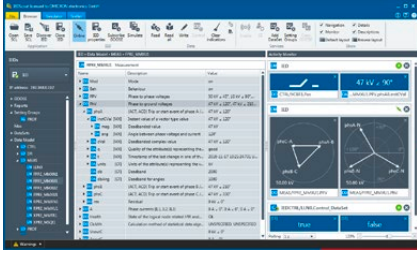

Essential	Standard	Enhanced	Complete	IEC 61850 Basic	IEC 61850 Advanced
<input type="checkbox"/>	<input type="checkbox"/>	<input type="checkbox"/>	<input type="checkbox"/>	<input checked="" type="checkbox"/>	<input checked="" type="checkbox"/>

IEDScout

IEDScout is the perfect tool for looking into IEC 61850 devices. It works with devices of all vendors and can be used for analysis and simulation of IEDs. While StationScout (see page 35) is used for getting an overview of the Substation Automation System and testing its logic and communication functions, IEDScout allows testing the IEC 61850 functionality of a single IED. Its application area ranges from IED development, factory acceptance testing, and commissioning to troubleshooting.

Order No.	Delivery contents
P0006493	IEDScout for PC
P0006778	IEDScout for MBX1 or RBX1

IEDScout is available as PC software, or on MBX1/RBX1 platform for cyber secure isolation of the PC from the network.

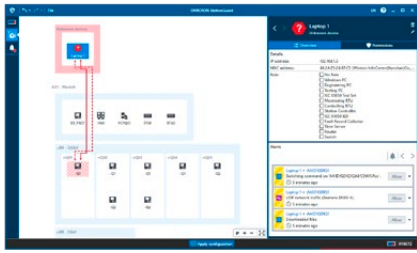

StationGuard

StationGuard monitors the network to detect cyber threats and functional problems on the station and process bus. It derives a system model of all communication by importing substation's SCL file. Devices not included in the SCL file can be described easily using a set of function templates.

StationGuard analyzes all communication on the network and it will raise an alarm if one device communicates with a protocol or in a way that does not comply with the functional model. Through the use of this functional communications model, StationGuard not only detects cyber threats in substation networks, but also configuration errors, excessive GOOSE network or processing delays, and time synchronization issues.

Order No.	Delivery contents
P0006779	StationGuard Cybersecurity and functional monitoring for substations.
	StationGuard Subscription Each StationGuard device is associated with a service contract for new features, security updates and expert support.

StationGuard can only be used together with the cyber-secure hardware platforms RBX1 for permanent installation or MBX1 for mobile usage. For more detailed information, please visit www.omiconenergy.com/stationguard or refer to the StationGuard product brochure.

MBX1

The industrial-grade MBX1 hardware is equipped with encrypted storage, a cryptoprocessor module, and secure firmware. The MBX1 is the cyber secure interface connecting the computer running IEDScout, StationScout or StationGuard to the substation network.

RBX1

The 19" platform RBX1 is tailor-made to be installed in substations. It is equipped with optical (SFP) Ethernet interfaces and power supplies for different DC voltage ranges and with a secure cryptoprocessor to securely store certificates and encryption keys.



IEC 61850 modules for Test Universe

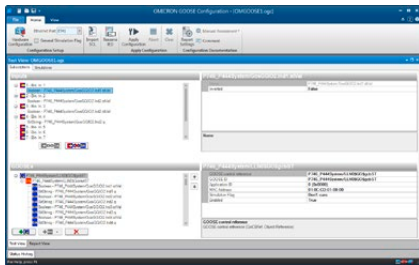

GOOSE Configuration

Essential	Standard	Enhanced	Complete	IEC 61850 Basic	IEC 61850 Advanced
<input type="checkbox"/>	<input type="checkbox"/>	<input type="checkbox"/>	<input checked="" type="checkbox"/>	<input checked="" type="checkbox"/>	<input checked="" type="checkbox"/>

GOOSE Configuration (P0006831) configures the mappings and sets up the CMC test set for communicating with the GOOSE messages on the substation network. It is used in OCC test plans to automatically configure the wiring. Configuration parameters can be imported from SCL files.

CMC test sets interact with status data in GOOSE messages as if they were wired to the binary inputs and outputs of the CMC. Received (subscribed) GOOSE messages actuate the binary inputs and binary output state changes initiate GOOSE message publication. This allows all relevant test modules to be used with GOOSE.

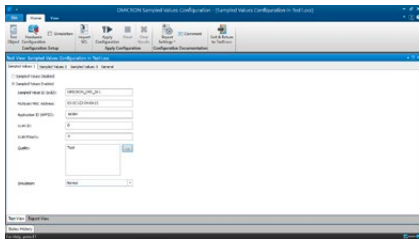

Sampled Values Configuration

Essential	Standard	Enhanced	Complete	IEC 61850 Basic	IEC 61850 Advanced
<input type="checkbox"/>	<input type="checkbox"/>	<input type="checkbox"/>	<input checked="" type="checkbox"/>	<input type="checkbox"/>	<input checked="" type="checkbox"/>

Sampled Values Configuration (P0006833) configures the Sampled Values (SV) generated by a CMC test set. The number of SV streams depends on the test software used. Configuration parameters can be imported from SCL files.

The available variants of SV correspond to the UCA implementation guideline for IEC 61850-9-2 ("9-2LE") and selected variants of IEC 61869-9. Configurable datasets are supported. Based on such SV configurations, all relevant test modules of Test Universe can be used with SV.

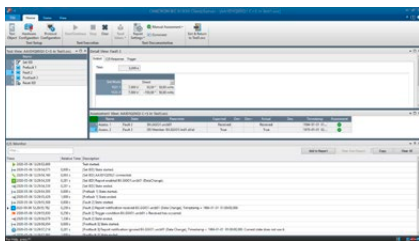

IEC 61850 Client/Server

Essential	Standard	Enhanced	Complete	IEC 61850 Basic	IEC 61850 Advanced
<input type="checkbox"/>	<input type="checkbox"/>	<input type="checkbox"/>	<input checked="" type="checkbox"/>	<input checked="" type="checkbox"/>	<input checked="" type="checkbox"/>

IEC 61850 Client/Server (P0006834) performs protection testing by utilizing IEC 61850 SCADA (MMS) reports. This allows for the verification that the IED issues the correct reports to the SCADA system. The module has access to the entire data model of the IED and may interrogate any data attribute during testing. The module also controls the IED's operation mode to isolate the IED under test.

IEC 61850 Packages

The IEC 61850 modules and tools are available in convenient combinations, depending on the intended application.

Package	IEC 61850 C/S	GOOSE Configuration	Sampled Values Configuration	IEDScout for PC	IEDScout for MBX1	MBX1
IEC 61850 Basic P0006594	<input checked="" type="checkbox"/>	<input checked="" type="checkbox"/>		<input checked="" type="checkbox"/>		
IEC 61850 Advanced P0006595	<input checked="" type="checkbox"/>	<input checked="" type="checkbox"/>	<input checked="" type="checkbox"/>	<input checked="" type="checkbox"/>		
IEC 61850 Basic + MBX1 P0006598	<input checked="" type="checkbox"/>	<input checked="" type="checkbox"/>			<input checked="" type="checkbox"/>	<input checked="" type="checkbox"/>
IEC 61850 Advanced + MBX1 P0006599	<input checked="" type="checkbox"/>	<input checked="" type="checkbox"/>	<input checked="" type="checkbox"/>		<input checked="" type="checkbox"/>	<input checked="" type="checkbox"/>

IEC 61850 Testing & Cybersecurity

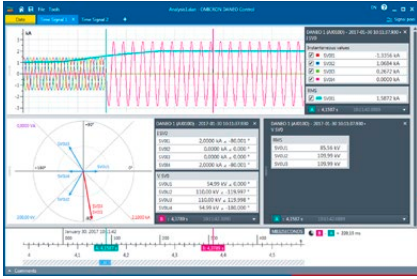

DANEO 400

DANEO 400 is a multimeter and fault recorder for IEC 61850 and conventional signals (voltages, currents, hardwired binary status signals). The hybrid measuring system measures both types of signals and provides information to assess their proper coordination. Information relating to operational status and communication helps operators to monitor the processes in the installation.

A measuring system containing multiple DANEO 400 devices will provide a time-coordinated picture of the signals from a distributed protection and automation system. All data acquisition devices are precisely time-synchronized. DANEO 400 devices are configured and controlled using the DANEO Control PC software. The integrated web interface provides access to dedicated functions.



Order No.	Delivery contents
P0006500	DANEO 400 Basic Signal analyzer for power utility automation systems. Measuring and recording conventional (analog and binary) signals.
P0006501	DANEO 400 Standard Hybrid signal analyzer for power utility automation systems. Measuring and recording conventional (analog and binary) signals and traffic from power utility communication networks (GOOSE and Sampled Values).

For more detailed information, please visit www.omronenergy.com/daneo400 or refer to the DANEO 400 product brochure.

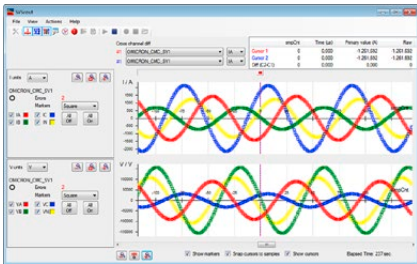

SVScout

SVScout (P0006496) makes Sampled Values (SV) visible for the substation engineer and IED developer. It subscribes to Sampled Values streams from merging units and displays the waveforms of the primary voltages and currents in an oscilloscope view. The data is displayed with electrical units. Detailed values on the traces can be looked up and compared with each other utilizing the cursor functions. The RMS values and phase angles are calculated from the Sampled Values and displayed in a phasor diagram and a measurement table.

Captured Sampled Values can be saved in COMTRADE files for further in-depth analysis. SV network traffic saved in Packet Capture (PCAP) files can be analyzed in SVScout.

ISIO 200



ISIO 200 is a simple, versatile binary input/output extension for Substation Automation Systems (SAS). In the case of CMC test sets it extends the binary inputs and outputs, while as a standalone component in an SAS it receives or outputs additional binary signals.

For more information, see page 57.



Asset and maintenance management solution for protection systems

ADMO is an easy-to-use database software for the central planning, management and documentation of all testing and maintenance activities for protection systems. Users can optimize their maintenance strategy, comply with standards (e.g. NERC PRC-005-2 for power suppliers in North America), and successfully pass audits.

In addition to protective relays, ADMO also allows users to manage communication systems, control circuitry, current and voltage transformers, circuit breakers, station DC supplies, energy meters, and transformers. It stores locations, asset data, maintenance cycles, and all associated test documents, providing a clear overview of all maintenance work that is due as well as the current maintenance status of individual facilities. Stored test documents and maintenance information can be accessed quickly.

Key features

- > Central and well-structured management of test documents, maintenance and commissioning tests, and protection settings
- > Maintenance status overview of the complete protection system and of primary assets such as current transformers
- > Efficient workflows for field testing and setting management
- > Tracking and analysis of network disturbance events
- > Easy-to-use visualization and versioning of protection coordination; maintenance of time grading schedules (ADMO Time Grading)
- > Convenient analysis of ADMO data with web application InSight for optimized asset life cycle management, investment and human resources planning
- > Support of modern IT security requirements

Test Set Management

ADMO's Test Set Management section enables users to easily organize test sets. They can add the test sets they use for their maintenance tasks, store test set specific data, schedule test set calibration, and keep track of repair events. The Test Set Management section is included in all Test Universe packages (see page 9).

ADMO licence options

Depending on the users' requirements, ADMO is available as a Client Server or Stand Alone Edition:

- > The Client Server Edition allows multiple users to work with ADMO simultaneously and to retrieve asset and maintenance data at any time in the field and in the office. The data is stored and updated on a central SQL server, which makes it available across the entire network. An offline copy of the ADMO database also enables users to access test documents when a network connection is not available.
- > The Stand Alone Edition is ideal for the coordination of maintenance activities by a single user.

ADMO light

All Test Universe packages (see page 9) include a free license of ADMO light, which offers full functionality but is limited to 50 assets. ADMO light can be upgraded to a full ADMO version at any time.

For more detailed information, please visit www.omicronenergy.com/admo or refer to the ADMO product brochure.

Overview of Technical Specifications ¹

CMC 356

Current amplifier

Setting range	6-phase AC (L-N)	6 x 0 ... 32 A
	3-phase AC (L-N)	3 x 0 ... 64 A (Group A II B)
	1-phase AC (LL-LN)	1 x 0 ... 128 A (Group A II B)
	DC (LL-LN)	1 x 0 ... ±180 A (Group A II B)
Power	6-phase AC (L-N)	6 x 430 VA typ. at 25 A 6 x 250 W guar. at 20 A
	3-phase AC (L-N)	3 x 860 VA typ. at 50 A 3 x 500 W guar. at 40 A
	1-phase AC (L-L-L-L)	1 x 1740 VA typ. at 25 A 1 x 1100 W guar. at 20 A

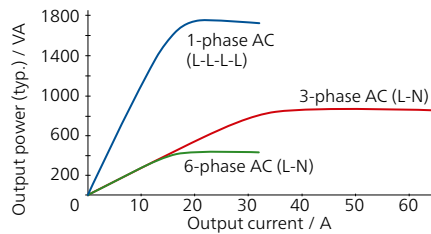

Accuracy	Error < 0.05 % rd. ² + 0.02 % rg. ² typ. Error < 0.15 % rd. + 0.05 % rg. guar.
Distortion (THD+N) ³	< 0.05 % typ., < 0.15 % guar.
Resolution	1 mA
Max. compliance voltage (L-N)/(L-L)/(L-L-L-L)	35 Vpk / 70 Vpk / 140 Vpk

Amplifiers, general

Frequency	Range sine signals ⁴	10 ... 1000 Hz
	Range harmonics / interharmonics	Voltage: 10 ... 3000 Hz ⁵ Current: 10 ... 1000 Hz
	Range transient signals	DC ... 3.1 kHz ⁵
	Resolution	< 5 μHz
Phase	Resolution	0.001°
	Error at 50 / 60 Hz	Voltage: 0.02° typ., < 0.1° guar. Current: 0.05° typ., < 0.2° guar. ³
Bandwidth (-3 dB)		3.1 kHz

Voltage amplifier

Setting range	4-phase AC (L-N)	4 x 0 ... 300 V
	2-phase AC (L-L)	2 x 0 ... 600 V
	DC (L-N)	4 x 0 ... ±300 V
Power	4-phase AC (L-N)	4 x 75 VA typ. at 100 ... 300 V 4 x 50 VA guar. at 85 ... 300 V
	3-phase AC (L-N)	3 x 100 VA typ. at 100 ... 300 V 3 x 85 VA guar. at 85 ... 300 V
	1-phase AC (L-L)	1 x 275 VA typ. at 200 ... 600 V 1 x 250 VA guar. at 200 ... 600 V

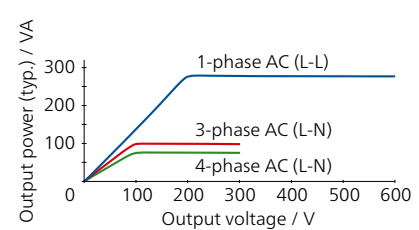

Accuracy (at 0 ... 300 V)	Error < 0.03 % rd. ² + 0.01 % rg. ² typ. Error < 0.08 % rd. + 0.02 % rg. guar.
Distortion (THD+N) ³	0.015 % typ., < 0.05 % guar.
Resolution	5 mV / 10 mV in range 150 V / 300 V
Ranges	150 V / 300 V

Low level outputs

Number of outputs	6 (12 with Option LLO-2)
Setting range	0 ... ±10 Vpk

Auxiliary DC supply

Voltage ranges, max. current	0 ... 264 VDC, 0.2 A
	0 ... 132 VDC, 0.4 A
	0 ... 66 VDC, 0.8 A

Binary inputs

Number	10 (5 potential groups)
Trigger criteria	Toggling of potential-free contacts or DC voltage compared to threshold voltage
Ranges	20 V / 300 V
	If equipped with ELT-1 ⁶ : 100 mV / 1 V / 10 V / 100 V / 600 V
Sampling rate	10 kHz (resolution 100 μs)

Binary outputs

Type	4 relay
	4 transistor
Relay breaking capacity	Imax: 8 A / Pmax: 2000 VA at 300 VAC
	Imax: 8 A / Pmax: 50 W at 300 VDC

¹ The full technical specifications are available on request. All data specified are guaranteed, except where indicated otherwise. OMICRON guarantees the specified data for one year after factory calibration, within 23 °C ± 5 °C / 73 °F ± 10 °F in the frequency range from 10 to 100 Hz and after a warm-up phase > 25 minutes

² rd. = reading, rg. = range

³ THD+N: Values at 50/60 Hz, 20 kHz measurement bandwidth

⁴ For current outputs amplitude derating at > 380 Hz

⁵ Amplitude derating at > 1000 Hz

⁶ The ELT-1 hardware option turns the ten binary inputs into multifunctional analog AC and DC voltage measuring inputs and adds two DC measuring inputs (0 ... 10 V / 0 ... 20 mA) for transducer testing



DC measuring inputs (If option ELT-1 is equipped ¹⁾)

Measuring range voltage	0 ... ±10 V
Measuring range current	0 ... ±1 mA, 0 ... ±20 mA

Analog AC + DC measuring inputs (If option ELT-1 is equipped ^{1,2)})

Type	AC + DC analog voltage inputs (current measurement with external current clamps or shunt resistors)
Number	10
Nominal input ranges (RMS values)	100 mV / 1 V / 10 V / 100 V / 600 V
Amplitude accuracy	Error < 0.06 % typ., < 0.15 % guar.

IEC 61850³⁾

Publishing	
GOOSE	360 virtual binary outputs, 128 GOOSEs
Sampled Values	IEC 61850-9-2 („9-2LE“), IEC 61869-9

Subscribing	
GOOSE	360 virtual binary inputs, 128 GOOSEs

Maximum number of streams	
Publishing	RelaySimTest: 4, Test Universe: 3 (1 stream: 4 V + 4 I)

Time synchronization

Internal system clock	
Frequency drift	< 0.37 ppm / 24 h < 4.6 ppm / 20 years

CMC 356 to external reference	
Absolute timing accuracy (voltage/current)	< 1 µs typ., < 5 µs guar.
To external voltage	Reference signal on binary input 10: 10 ... 300 V / 15 ... 70 Hz
Precision Time Protocol (PTP)	IEEE 1588-2008 IEEE C37.238 (Power Profile) IEC 61850-9-3 (Utility Profile)

CMC 356 to test objects	
IRIG-B, PPS, PPX	Via CMIRIG-B, TICRO 100

Power supply

Nominal	100 ... 240 VAC, 1-phase (50/60 Hz)
---------	-------------------------------------

Environmental conditions

Operation temperature ⁴⁾	0 ... +50 °C / +32 ... +122 °F
Storage temperature	-25 ... +70 °C / -13 ... +158 °F
Relative humidity	5 ... 95 %, non-condensing

Equipment reliability

Electromagnetic interference (EMI)	
International / Europe	IEC/EN 61326-1, IEC/EN 61000-6-4, IEC/EN 61000-3-2/3, CISPR 32 (Class A)/EN 55032 (Class A)
North America	47 CFR 15 Subpart B (Class A) of FCC

Electromagnetic susceptibility (EMS)	
International / Europe	IEC/EN 61326-1, IEC/EN 61000-6-2/5, IEC/EN 61000-4-2/3/4/5/6/8/11/16/18

Safety	
International / Europe	IEC/EN 61010-1, IEC/EN 61010-2-030
North America	UL 61010-1, UL 61010-2-030, CAN/CSA-C22.2 No. 61010-1, CAN/CSA-C22.2 No. 61010-2-030

Mechanical tests	
Vibration	IEC 60068-2-6
Shock	IEC 60068-2-27

Miscellaneous

Weight	16.8 kg / 37.0 lbs
Dimensions (W x H x D, without handle)	450 x 145 x 390 mm / 17.7 x 5.7 x 15.4 in
PC connection	2 PoE (Power over Ethernet) ports USB Type-B port (PC) USB Type-A port (optional Wi-Fi adapter for wireless control)

Certifications

Developed and manufactured under an ISO 9001 registered system



¹⁾ The ELT-1 hardware option turns the ten binary inputs into multifunctional analog AC and DC voltage measuring inputs and adds two DC measuring inputs (0 ... 10 V / 0 ... 20 mA) for transducer testing

²⁾ Up to three inputs can be used for measuring RMS values, frequency, and phase angle without the EnerLyzer software license. Full functionality requires EnerLyzer software license

³⁾ The GOOSE and Sampled Values functionality require software licences for the respective configuration modules

⁴⁾ For an operational temperature above +30 °C / +86 °F a duty cycle of down to 50 % may apply

Overview of Technical Specifications ¹

CMC 256plus

Current amplifier

Setting range	6-phase AC (L-N)	6 x 0 ... 12.5 A
	3-phase AC (L-N)	3 x 0 ... 25 A (Group A II B)
	1-phase AC (L-N)	1 x 0 ... 75 A (Group A II B)
	DC (L-N)	1 x 0 ... ±35 A (Group A II B)
Power	6-phase AC (L-N)	6 x 80 VA typ. at 8.5 A 6 x 70 VA guar. at 7.5 A
	3-phase AC (L-N)	3 x 160 VA typ. at 17 A 3 x 140 VA guar. at 15 A
	1-phase AC (L-N)	1 x 480 VA typ. at 51 A 1 x 420 VA guar. at 45 A

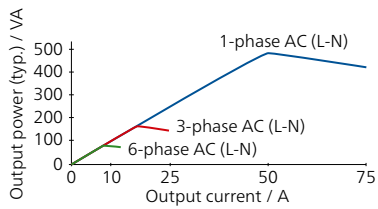

Accuracy	Error < 0.015 rd. ² + 0.005 % rg. ² typ. Error < 0.04 % rd. + 0.01 % rg. guar.
Distortion (THD+N) ³	< 0.025 % typ., < 0.07 % guar.
Resolution (for respective range)	50 µA / 100 µA / 500 µA / 1 mA
Max. compliance voltage (L-N)/(L-L)	15 Vpk / 60 Vpk

Amplifiers, general

Frequency	Range sine signals	10 ... 1000 Hz
	Range harmonics / interharmonics	10 ... 3000 Hz ⁴
	Range transient signals	DC ... 3.1 kHz ⁴
	Resolution	< 5 µHz
Phase	Resolution	0.001°
	Error at 50 / 60 Hz	< 0.005° typ., < 0.02° guar.
Bandwidth (-3 dB)		3.1 kHz

Voltage amplifier

Setting range	4-phase AC (L-N)	4 x 0 ... 300 V
	2-phase AC (L-L)	2 x 0 ... 600 V
	DC (L-N)	4 x 0 ... ±300 V
Power	4-phase AC (L-N)	4 x 75 VA typ. at 100 ... 300 V 4 x 50 VA guar. at 85 ... 300 V
	3-phase AC (L-N)	3 x 100 VA typ. at 100 ... 300 V 3 x 85 VA guar. at 85 ... 300 V
	1-phase AC (L-L)	1 x 275 VA typ. at 200 ... 600 V 1 x 250 VA guar. at 200 ... 600 V

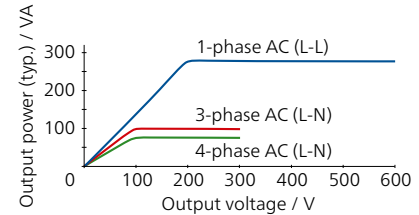

Accuracy (at 0 ... 300 V)	Error < 0.015 % rd. ² + 0.005 % rg. ² typ. Error < 0.04 % rd. + 0.01 % rg. guar.
Distortion (THD+N) ³	0.015 % typ., < 0.05 % guar.
Resolution	5 mV / 10 mV in range 150 V / 300 V
Ranges	150 V / 300 V

Low level outputs

Number of outputs	6 (12 with Option LLO-2)
Setting range	0 ... ±10 Vpk

Auxiliary DC supply

Voltage ranges, max. current	0 ... 264 VDC, 0.2 A
	0 ... 132 VDC, 0.4 A
	0 ... 66 VDC, 0.8 A

Binary inputs

Number	10 (5 potential groups)
Trigger criteria	Toggle of potential-free contacts or DC voltage compared to threshold voltage
Ranges	100 mV / 1 V / 10 V / 100 V / 600 V
Sampling rate	10 kHz (resolution 100 µs)

Binary outputs

Type	4 relay 4 transistor
Relay breaking capacity	Imax: 8 A / Pmax: 2000 VA at 300 VAC Imax: 8 A / Pmax: 50 W at 300 VDC

¹ The full technical specifications are available on request. All data specified are guaranteed, except where indicated otherwise. OMICRON guarantees the specified data for one year after factory calibration, within 23 °C ±5 °C / 73 °F ±10 °F in the frequency range from 10 to 100 Hz and after a warm-up phase > 25 minutes

² rd. = reading, rg. = range

³ Values at 50/60 Hz, 20 kHz measurement bandwidth, nominal value, and nominal load

⁴ Amplitude derating at > 1000 Hz



DC measuring inputs

Measuring range voltage	0 ... ±10 V
Measuring range current	0 ... ±1 mA, 0 ... ±20 mA

Analog AC + DC measuring inputs¹

Type	AC + DC analog voltage inputs (current measurement with external current clamps or shunt resistors)
Number	10
Nominal input ranges (RMS values)	100 mV / 1 V / 10 V / 100 V / 600 V
Amplitude accuracy	Error < 0.06 % typ., < 0.15 % guar.

IEC 61850²

Publishing	
GOOSE	360 virtual binary outputs, 128 GOOSEs
Sampled Values	IEC 61850-9-2 („9-2LE“), IEC 61869-9

Subscribing	
GOOSE	360 virtual binary inputs, 128 GOOSEs

Maximum number of streams	
Publishing	RelaySimTest: 4, Test Universe: 3 (1 stream: 4 V + 4 I)

Time synchronization

Internal system clock	
Frequency drift	< 0.37 ppm / 24 h < 4.6 ppm / 20 years

CMC 256plus to external reference	
Absolute timing accuracy (voltage/current)	< 1 µs typ., < 5 µs guar.
To external voltage	Reference signal on binary input 10: 10 ... 300 V / 15 ... 70 Hz
Precision Time Protocol (PTP)	IEEE 1588-2008 IEEE C37.238 (Power Profile) IEC 61850-9-3 (Utility Profile)

CMC 256plus to test objects	
IRIG-B, PPS, PPX	Via CMIRIG-B, TICRO 100

Power supply

Nominal	100 ... 240 VAC, 1-phase (50/60 Hz)
---------	-------------------------------------

Environmental conditions

Operation temperature ³	0 ... +50 °C / +32 ... +122 °F
Storage temperature	-25 ... +70 °C / -13 ... +158 °F
Relative humidity	5 ... 95 %, non-condensing

Equipment reliability

Electromagnetic interference (EMI)	
International / Europe	IEC/EN 61326-1, IEC/EN 61000-6-4, IEC/EN 61000-3-2/3, CISPR 32 (Class A)/EN 55032 (Class A)
North America	47 CFR 15 Subpart B (Class A) of FCC

Electromagnetic susceptibility (EMS)	
International / Europe	IEC/EN 61326-1, IEC/EN 61000-6-2/5, IEC/EN 61000-4-2/3/4/5/6/8/11/16/18

Safety	
International / Europe	IEC/EN 61010-1, IEC/EN 61010-2-030
North America	UL 61010-1, UL 61010-2-030, CAN/CSA-C22.2 No. 61010-1, CAN/CSA-C22.2 No. 61010-2-030

Mechanical tests	
Vibration	IEC 60068-2-6
Shock	IEC 60068-2-27

Miscellaneous

Weight	16.0 kg / 35.3 lbs
Dimensions (W x H x D, without handle)	450 x 145 x 390 mm / 17.7 x 5.7 x 15.4 in
PC connection	2 PoE (Power over Ethernet) ports USB Type-B port (PC) USB Type-A port (optional Wi-Fi adapter for wireless control)

Certifications

Developed and manufactured under an ISO 9001 registered system



¹ Up to three inputs can be used for measuring RMS values, frequency, and phase angle without the EnerLyzer software license. Full functionality requires EnerLyzer software license

² The GOOSE and Sampled Values functionality require software licences for the respective configuration modules

³ For an operational temperature above +30 °C / +86 °F a duty cycle of down to 50 % may apply

Overview of Technical Specifications ¹

CMC 430

Current amplifier

Setting range	3-phase AC (L-N)	3 x 0 ... 12.5 A
	1-phase AC (L-L)	1 x 0 ... 12.5 A
	1-phase AC (LLL-N)	1 x 0 ... 37.5 A
	DC (LLL-N)	1 x 0 ... ±37.5 A
Power	3-phase AC (L-N)	3 x 90 W typ. at 9 A 3 x 85 W guar. at 9 A
	1-phase AC (L-L)	1 x 180 W typ. at 9 A 1 x 170 W guar. at 9 A
	1-phase AC (LLL-N)	1 x 250 W typ. at 24 A
		1 x 200 W guar. at 24 A

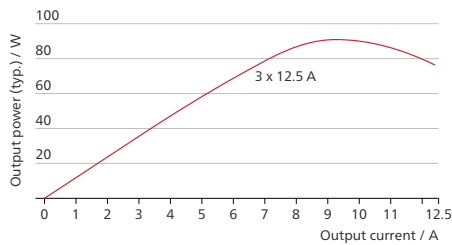

Current magnitude accuracy

Range	typical ^{2,3}	1 year ²	2 years ²
10...100 Hz; I < 6 A	0.02 + 0.005	0.04 + 0.01	0.07 + 0.01
10...100 Hz; I > 6 A		0.08 + 0.01	0.11 + 0.01
Resolution		100 µA	
Max. compliance voltage (L-N/L-L)		17 Vpk / 34 Vpk	
Ranges		1.25 A / 12.5 A	

General amplifier specifications

Frequency range	Sine signals	DC ... 1000 Hz
	Harmonics, Inter-harmonic, Transients	DC ... 3000 Hz
Resolution	< 5 µHz	
Phase accuracy 50/60 Hz (ref V1)	0.005° typ.	0.02° guar.
THD+N at 50/60 Hz	< 0.1 % at full scale	
Simulated Power/ Energy (1 Year)	0.1 % of set value at 50/60 Hz; PF = 1 50 V to 70 V at < 2 W 0.05 A to 6 A at < 0.3 Ohm	

Voltage amplifier

Setting range	6-phase AC (L-N)	6 x 0 ... 150 V
	3-phase AC (L-L)	3 x 0... 300 V (without common N)
	DC (L-N)	3 x 0 ... ±212 V
Power	6-phase AC (L-N)	6 x 42 W typ. at 150 V 6 x 37.5 W guar. at 150 V
	3-phase AC (L-L)	3 x 42 W typ. at 150 V 3 x 37.5 W guar. at 150 V
	1-phase AC (L-L)	1 x 84 W typ. at 300 V 1 x 75 W guar. at 300 V

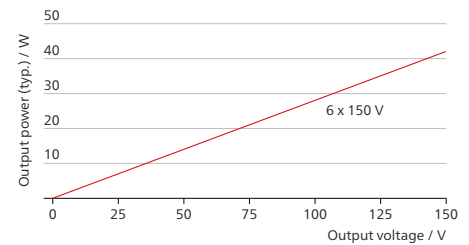

Voltage magnitude accuracy

Range	typical ^{2,3}	1 year ²	2 years ²
10...100 Hz (V1-V3)	0.015 + 0.005	0.04 + 0.01	0.06 + 0.01
10...100 Hz (V4-V6)		0.07 + 0.01	0.11 + 0.01
Resolution		100 µV	

Auxiliary DC supply

Voltage range	12 ... 264 VDC
Power	Inrush (< 2 s) 120 W / 2 A Continuous 50 W / 0.8 A

Binary inputs

Number	6 (each fully isolated)
Trigger criteria	Toggleing of potential-free contacts, AC or DC voltage compared to threshold voltage
Ranges	10 mV / 100 mV / 1 V / 10 V / 100 V / 600 V
Sampling rate	10 kHz (resolution 100 µs)
Max. measuring time	Infinite

Binary outputs

Type	4 relay 4 transistor
Relay breaking capacity	I _{max} : 8 A / P _{max} : 2000 VA at 300 VAC I _{max} : 8 A / P _{max} : 50 W at 300 VDC

¹ The full technical specifications are available on request. All data specified are guaranteed, except where indicated otherwise. OMICRON guarantees the specified data for one year after factory calibration, within 23 °C ±5 °C / 73 °F ±10 °F in the frequency range from 10 to 100 Hz and after a warm-up phase > 30 minutes

² ± (% of set value + % of range) or better

³ Typical values apply to 98 % of all devices immediately after a factory calibration (adjustment)



DC measuring inputs

Measuring range voltage	$\pm 10 \text{ mV}$, $\pm 100 \text{ mV}$, $\pm 1 \text{ V}$, $\pm 10 \text{ V}$
Measuring range current	$\pm 1 \text{ mA}$, $\pm 20 \text{ mA}$

Analog AC + DC measuring inputs

Number	6, each fully isolated
Sampling frequency	10 kHz, 40 kHz (configurable)
Nominal input ranges (RMS values)	10 mV / 100 mV / 1 V / 10 V / 100 V / 600 V
Amplitude accuracy (1 V/10 V/100 V)	0.08 + 0.03 (1 year ¹) 0.11 + 0.04 (2 years ¹)
Analog measurement quantities	I, V (AC/DC, RMS and instantaneous), ϕ , f; P, Q, S, harmonics (up to 64 th), df/dt
Hybrid ² recording while analog outputs are active	With software option EnerLyzer Live

IEC 61850³

Publishing	
GOOSE	360 virtual binary outputs, 128 GOOSEs
Sampled Values	IEC 61850-9-2 („9-2LE“), IEC 61869-9

Subscribing	
GOOSE	360 virtual binary inputs, 128 GOOSEs
Sampled Values	IEC 61850; IEC 61869-9

Maximum number of streams	
Publishing	RelaySimTest: 4, Test Universe: 3
Subscribing	2

Time synchronization

Internal system clock	
Frequency drift	< 0.37 ppm / 24 h < 4.6 ppm / 20 years

CMC 430 to external reference	
Absolute timing accuracy (voltage/current)	< 1 μs typ., < 5 μs guar.
To external voltage	Reference signal on binary input 6: 10 ... 600 V / 15 ... 70 Hz
Precision Time Protocol (PTP)	IEEE 1588-2008 IEEE C37.238-2011 (Power Profile) IEC 61869-9-3 (Utility Profile)

CMC 430 to test objects	
IRIG-B, PPS, PPX	Via CMIRIG-B, TICRO 100

Power supply

Nominal	100 ... 240 V, 50/60 Hz, 1000 W
---------	---------------------------------

Environmental conditions

Operation temperature	-25 ... +50 °C / -13 ... +122 °F
Storage temperature	-40 ... +70 °C / -40 ... +158 °F
Relative humidity	5 ... 95 %, non-condensing

Equipment reliability

Electromagnetic interference (EMI)	
International / Europe	IEC/EN 61326-1, IEC/EN 61000-6-4, IEC/EN 61000-3-2/3, CISPR 32 (Class A)/EN 55032 (Class A)
North America	47 CFR 15 Subpart B (Class A) of FCC

Electromagnetic susceptibility (EMS)	
International / Europe	IEC/EN 61326-1, IEC/EN 61000-4-2/3/4/5/6/8/11

Safety	
International / Europe	IEC/EN 61010-1, IEC/EN 61010-2-030
North America	UL 61010-1, UL 61010-2-030, CAN/CSA-C22.2 No. 61010-1, CAN/CSA-C22.2 No. 61010-2-030

Mechanical tests	
Classification	IEC 60721-3-7
Vibration	IEC 60068-2-64
Shock	IEC 60068-2-27
Free fall	IEC 60068-2-31

Miscellaneous

Weight	8.7 kg / 19.2 lbs
Dimensions	270 x 150 x 380 mm / 10.6 x 5.9 x 15.0 in
Interfaces	2 PoE ethernet ports 1 USB Type-B port 1 USB Type-A port 1 External interface: For ARC 256x, SEM1, SEM2, SEM3, SER1, CMIRIG-B 4 Expansion ports: For LLX1–LLX4 and expansion mode LED indication status of analog output signals Configurable beeper

Certifications

Developed and manufactured under an ISO 9001 registered system



¹ \pm (% of reading + % of range) or better

² Analog, binary, SV and GOOSE

³ The GOOSE and Sampled Values functionality require software licences for the respective configuration modules

Overview of Technical Specifications ¹

CMC 353

Current amplifier

Setting range	3-phase AC (L-N)	3 x 0 ... 32 A
	1-phase AC (L-L)	1 x 0 ... 32 A
	1-phase AC (LL-LN)	1 x 0 ... 64 A
	DC (LL-LN)	1 x 0 ... 64 A
Power	3-phase AC (L-N)	3 x 430 VA typ. at 25 A 3 x 250 W guar. at 20 A
	1-phase AC (L-L)	1 x 870 VA typ. at 25 A 1 x 530 W guar. at 20 A
	1-phase AC (LL-LN)	1 x 500 VA typ. at 40 A 1 x 350 W guar. at 40 A

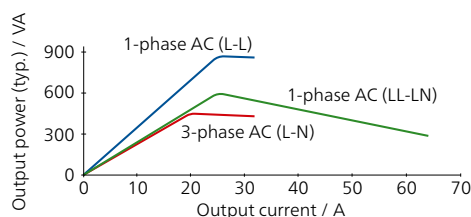

Accuracy	Error < 0.05 % rd. ² + 0.02 % rg. ² typ. Error < 0.15 % rd. + 0.05 % rg. guar.
Distortion (THD+N) ³	< 0.05 % typ., < 0.15 % guar.
Resolution	1 mA
Max. compliance voltage (L-N)/(L-L)	35 Vpk / 70 Vpk

Amplifiers, general

Frequency	Range sine signals ⁴	10 ... 1000 Hz
	Range harmonics / interharmonics	Voltage: 10 ... 3000 Hz ⁵ Current: 10 ... 1000 Hz
	Range transient signals	DC ... 3.1 kHz ⁵
	Resolution	< 5 μHz
Phase	Resolution	0.001°
	Error at 50 / 60 Hz	Voltage: 0.02° typ., < 0.1° guar. Current: 0.05° typ., < 0.2° guar.
Bandwidth (-3 dB)		3.1 kHz

Voltage amplifier

Setting range	4-phase AC (L-N)	4 x 0 ... 300 V
	2-phase AC (L-L)	2 x 0 ... 600 V
	DC (L-N)	4 x 0 ... ±300 V
Power	4-phase AC (L-N)	4 x 75 VA typ. at 100 ... 300 V 4 x 50 VA guar. at 85 ... 300 V
	3-phase AC (L-N)	3 x 100 VA typ. at 100 ... 300 V 3 x 85 VA guar. at 85 ... 300 V
	1-phase AC (L-L)	1 x 275 VA typ. at 200 ... 600 V 1 x 250 VA guar. at 200 ... 600 V

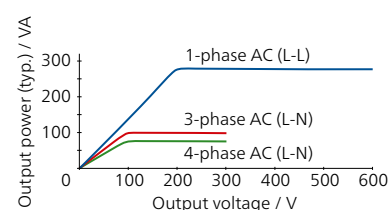

Accuracy (at 0 ... 300 V)	Error < 0.03 % rd. ² + 0.01 % rg. ² typ. Error < 0.08 % rd. + 0.02 % rg. guar.
Distortion (THD+N) ³	0.015 % typ., < 0.05 % guar.
Resolution	5 mV / 10 mV in range 150 V / 300 V
Ranges	150 V / 300 V

Low level outputs

Number of outputs	6 (12 with Option LLO-2)
Setting range	0 ... ±10 Vpk

Auxiliary DC supply

Voltage ranges, max. current	0 ... 264 VDC, 0.2 A
	0 ... 132 VDC, 0.4 A
	0 ... 66 VDC, 0.8 A

Binary inputs

Number	10 (5 potential groups)
Trigger criteria	Toggling of potential-free contacts or DC voltage compared to threshold voltage
Ranges	20 V / 300 V
Sampling rate	10 kHz (resolution 100 μs)

Binary outputs

Type	4 relay 4 transistor
Relay breaking capacity	I _{max} : 8 A / P _{max} : 2000 VA at 300 VAC I _{max} : 8 A / P _{max} : 50 W at 300 VDC

¹ The full technical specifications are available on request. All data specified are guaranteed, except where indicated otherwise. OMICRON guarantees the specified data for one year after factory calibration, within 23 °C ±5 °C / 73 °F ±10 °F in the frequency range from 10 to 100 Hz and after a warm-up phase > 25 minutes

² rd. = reading, rg. = range

³ THD+N: Values at 50/60 Hz, 20 kHz measurement bandwidth

⁴ For current outputs amplitude derating at > 380 Hz

⁵ Amplitude derating at > 1000 Hz



IEC 61850¹

Publishing

GOOSE	360 virtual binary outputs, 128 GOOSEs
Sampled Values	IEC 61850-9-2 („9-2LE“), IEC 61869-9

Subscribing

GOOSE	360 virtual binary inputs, 128 GOOSEs
-------	---------------------------------------

Maximum number of streams

Publishing	RelaySimTest: 4, Test Universe: 3 (1 stream: 4 V + 4 I)
------------	--

Time synchronization

Internal system clock

Frequency drift	< 0.37 ppm / 24 h < 4.6 ppm / 20 years
-----------------	---

CMC 353s to external reference

Absolute timing accuracy (voltage/current)	< 1 µs typ., < 5 µs guar.
To external voltage	Reference signal on binary input 10: 10 ... 300 V / 15 ... 70 Hz
Precision Time Protocol (PTP)	IEEE 1588-2008 IEEE C37.238 (Power Profile) IEC 61850-9-3 (Utility Profile)

CMC 353 to test objects

IRIG-B, PPS, PPX	Via CMIRIG-B, TICRO 100
------------------	-------------------------

Power supply

Nominal	100 ... 240 VAC, 1-phase (50/60 Hz)
---------	-------------------------------------

Environmental conditions

Operation temperature ²	0 ... +50 °C / +32 ... +122 °F
Storage temperature	-25 ... +70 °C / -13 ... +158 °F
Relative humidity	5 ... 95 %, non-condensing

Equipment reliability

Electromagnetic interference (EMI)

International / Europe	IEC/EN 61326-1, IEC/EN 61000-6-4, IEC/EN 61000-3-2/3, CISPR 32 (Class A)/EN 55032 (Class A)
North America	47 CFR 15 Subpart B (Class A) of FCC

Electromagnetic susceptibility (EMS)

International / Europe	IEC/EN 61326-1, IEC/EN 61000-6-2/5, IEC/EN 61000-4-2/3/4/5/6/8/11/16/18
------------------------	--

Safety

International / Europe	IEC/EN 61010-1, IEC/EN 61010-2-030
North America	UL 61010-1, UL 61010-2-030, CAN/CSA-C22.2 No. 61010-1, CAN/CSA-C22.2 No. 61010-2-030

Mechanical tests

Vibration	IEC 60068-2-6
Shock	IEC 60068-2-27

Miscellaneous

Weight	13.3 kg / 29.3 lbs
Dimensions (W x H x D, without handle)	343 x 145 x 390 mm / 13.5 x 5.7 x 15.4 in
PC connection	2 PoE (Power over Ethernet) ports USB Type-B port (PC) USB Type-A port (optional Wi-Fi adapter for wireless control)

Certifications

Developed and manufactured under an ISO 9001 registered system



¹ The GOOSE and Sampled Values functionality require software licences for the respective configuration modules

² For an operational temperature above +30 °C / +86 °F a duty cycle of down to 50 % may apply

Overview of Technical Specifications ¹

CMC 310

Current amplifier

Setting range	3-phase AC (L-N)	3 x 0 ... 32 A
	1-phase AC (L-L)	1 x 0 ... 32 A
	1-phase AC (LL-LN)	1 x 0 ... 64 A
	DC (LL-LN)	1 x 0 ... 64 A
Power	3-phase AC (L-N)	3 x 430 VA typ. at 25 A 3 x 250 W guar. at 20 A
	1-phase AC (L-L)	1 x 870 VA typ. at 25 A 1 x 530 W guar. at 20 A
	1-phase AC (LL-LN)	1 x 500 VA typ. at 40 A 1 x 350 W guar. at 40 A

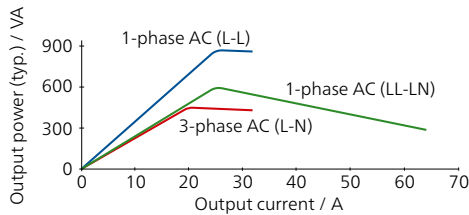

Accuracy	Error < 0.05 % rd. ² + 0.02 % rg. ² typ. Error < 0.15 % rd. + 0.05 % rg. guar.
Distortion (THD+N) ³	< 0.05 % typ., < 0.15 % guar.
Resolution	1 mA
Max. compliance voltage (L-N)/(L-L)	35 Vpk / 70 Vpk

Voltage amplifier

Setting range	3-phase AC (L-N)	3 x 0 ... 300 V
	1-phase AC (L-L)	1 x 0 ... 600 V
	DC (L-N)	3 x 0 ... ±300 V
Power	3-phase AC (L-N)	3 x 100 VA typ. at 100 ... 300 V 3 x 85 VA guar. at 85 ... 300 V
	1-phase AC (L-L)	1 x 275 VA typ. at 200 ... 600 V 1 x 250 VA guar. at 200 ... 600 V

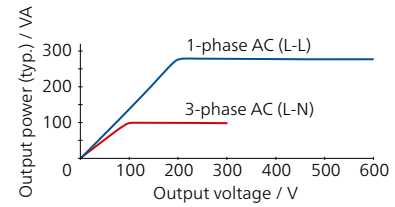

Accuracy (at 0 ... 300 V)	Error < 0.03 % rd. ² + 0.01 % rg. ² typ. Error < 0.08 % rd. + 0.02 % rg. guar.
Distortion (THD+N) ³	0.015 % typ., < 0.05 % guar.
Resolution	5 mV / 10 mV in range 150 V / 300 V
Ranges	150 V / 300 V

Amplifiers, general

Frequency	Range sine signals ⁴	10 ... 599 Hz
	Resolution	< 5 μHz
Phase	Resolution	0.001°
	Error at 50 / 60 Hz	Voltage: 0.02° typ., < 0.1° guar. Current: 0.05° typ., < 0.2° guar.

¹ The full technical specifications are available on request. All data specified are guaranteed, except where indicated otherwise. OMICRON guarantees the specified data for one year after factory calibration, within 23 °C ± 5 °C / 73 °F ± 10 °F in the frequency range from 10 to 100 Hz and after a warm-up phase > 25 minutes

² rd. = reading, rg. = range

³ THD+N: Values at 50/60 Hz, 20 kHz measurement bandwidth

⁴ For current outputs amplitude derating at > 380 Hz



Auxiliary DC supply

Voltage ranges, max. current	0 ... 264 VDC, 0.2 A 0 ... 132 VDC, 0.4 A 0 ... 66 VDC, 0.8 A
------------------------------	---

Binary inputs

Number	6
Trigger criteria	Toggling of potential-free contacts or DC voltage compared to threshold voltage
Ranges	20 V / 300 V
Sampling rate	10 kHz (resolution 100 µs)

Binary outputs

Type	4 relay 4 transistor
Relay breaking capacity	I _{max} : 8 A / P _{max} : 2000 VA at 300 VAC I _{max} : 8 A / P _{max} : 50 W at 300 VDC

Power supply

Nominal	100 ... 240 VAC, 1-phase (50/60 Hz)
---------	-------------------------------------

Environmental conditions

Operation temperature ¹	0 ... +50 °C / +32 ... +122 °F
Storage temperature	-25 ... +70 °C / -13 ... +158 °F
Relative humidity	5 ... 95 %, non-condensing

Equipment reliability

Electromagnetic interference (EMI)

International / Europe	IEC/EN 61326-1, IEC/EN 61000-6-4, IEC/EN 61000-3-2/3, CISPR 32 (Class A)/EN 55032 (Class A)
North America	47 CFR 15 Subpart B (Class A) of FCC

Electromagnetic susceptibility (EMS)

International / Europe	IEC/EN 61326-1, IEC/EN 61000-6-2/5, IEC/EN 61000-4-2/3/4/5/6/8/11/16/18
------------------------	--

Safety

International / Europe	IEC/EN 61010-1, IEC/EN 61010-2-030
North America	UL 61010-1, UL 61010-2-030, CAN/CSA-C22.2 No. 61010-1, CAN/CSA-C22.2 No. 61010-2-030

Mechanical tests

Vibration	IEC 60068-2-6
Shock	IEC 60068-2-27

Miscellaneous

Weight	13.1 kg / 28.9 lbs
Dimensions (W x H x D, without handle)	343 x 145 x 390 mm / 13.5 x 5.7 x 15.4 in
PC connection	2 PoE (Power over Ethernet) ports USB Type-B port (PC) USB Type-A port (optional Wi-Fi adapter for wireless control)

Certifications

Developed and manufactured under an ISO 9001 registered system



¹ For an operational temperature above +30 °C / +86 °F a duty cycle of down to 50 % may apply



CMC 850 – Protection test set dedicated to IEC 61850

The CMC 850 test set focuses specifically on IEC 61850 systems. It communicates with the test object using the real-time protocols GOOSE and Sampled Values. The test set is operated either with the Test Universe software or with RelaySimTest.

The CMC 850 is part of the CMC 850 package, which consists of optimized hardware and essential components of the Test Universe software. The package includes everything needed for time-synchronized testing with GOOSE and Sampled Values. For special protection testing applications, individual Test Universe modules can be ordered separately.

Technical Data

IEC 61850 GOOSE	
Simulation	Mapping of binary outputs to data attributes in published GOOSE messages. Number of virtual binary outputs: 360 Number of GOOSEs to be published: 128
Subscription	Mapping of data attributes from subscribed GOOSE messages to binary inputs. Number of virtual binary inputs: 360 Number of GOOSEs to be subscribed: 128
Performance	Type 1A; Class P2/3 (IEC 61850-5). Processing time (application to network or vice versa): < 1 ms
VLAN support	Selectable priority and VLAN-ID
IEC 61850 Sampled Values (Publishing)	
Specification	IEC 61850-9-2; IEC 61869-9 "9-2LE" DataSets
Sampling Rates	4 000 Hz, 4 800 Hz, 12 800 Hz, 15 360 Hz, 14 400 Hz
Synchronization	Synchronization attribute (smpSynch) is set when the CMC is in synchronized operation mode. Sample count (smpCnt) zero is aligned with top of the second Accuracy data see below
VLAN support	Selectable priority and VLAN-ID
Max. number of SV streams	RelaySimTest: 4, Test Universe: 3
Communications interfaces	
PC connection	Two PoE ¹ Ethernet ports: <ul style="list-style-type: none"> • 10/100/1000 Base-TX • IEEE 802.3af compliant • Port capability limited to one Class 1 (3.84 W) and one Class 2 (6.49 W) powered device USB ports: <ul style="list-style-type: none"> • USB Type-B port (PC) • USB Type-A port (Wi-Fi adapter for wireless control)
Time synchronization	
Timing accuracy	Error < 1 μs typ., < 5 μs guar.
IRIG-B synchronization with CMIRIG-B	Error < 1 μs typ., < 5 μs guar.
GPS synchronization with CMGPS 588	Error < 1 μs typ., < 5 μs guar.
Precision Time Protocol (PTP)	IEEE 1588-2008 IEEE C37.238-2011 (Power Profile) IEC/IEEE 61850-9-3 (Utility Profile)
With the unique PermaSync functionality, analog and Sampled Values outputs stay permanently in sync with the internal CMC time reference. When a CMC is time-synchronized (IRIG-B, GPS, or PTP), the output quantities are continuously synchronized to the external time source. With CMIRIG-B it is also possible to transmit the internal PPS signal of the CMC to the device under test (e.g. PMUs or IEDs stimulated with a synchronized Sampled Values data stream).	

Low level outputs ²	
Number of outputs	12
Setting range	0 ... ±10 Vpk
Max. output current	1 mA
Accuracy	Error < 0.025 % typ., < 0.07 % guar. at 1 ... 10 V
Resolution	250 μV
Distortion (THD+N) ³	< 0.015 % typ., < 0.05 % guar.
Unconventional CT/VT simulation	Linear, Rogowski (transient and sinewave)
Overload indication	Yes
Isolation	SELV
Connection	2 x 16 pin combination socket
Binary outputs, transistor	
Type	Open collector transistor outputs
Number	4
Update rate	10 kHz
Imax	5 mA
Connection	16 pin combination socket
External power supply unit	
Nominal / permissible input voltage	100 – 240 VAC / 99 ... 264 VAC (50/60 Hz)
Output voltage	48 VDC (±6.25 %)
Rated current	1.66 A
Rated power	80 W
Environmental conditions	
Operation temperature	0 ... +50 °C (+32 ... +122 °F)
Storage temperature	-25 ... +70 °C (-13 ... +158 °F)
Humidity range	Relative humidity 5 ... 95 %, non-condensing
Equipment reliability	
The product adheres to the electromagnetic compatibility (EMC) Directive (CE conform).	
EMC Emission	International / Europe North America
	IEC/EN 61326-1, CISPR 32/EN 55032 (Class A), IEC/EN 61000-3-2/3, IEC/EN 61000-6-4 47 CFR 15 Subpart B (Class A) of FCC
EMC Immunity	International / Europe
	IEC/EN 61326-1
The product adheres to the low voltage Directive (CE conform).	
Safety	International / Europe North America
	IEC/EN 61010-1 UL 61010-1, CAN/CSA-C22.2 No. 61010-1
Mechanical tests	International / Europe
	IEC 60068-2-6 (20 m/s ² at 10 ... 150 Hz) IEC 60068-2-27 (15 g/11 ms half-sine)
Mechanical data	
Weight	1.7 kg (3.7 lbs)
Dimensions (W x H x D)	85 x 145 x 325 mm (3.3 x 5.7 x 12.8 in)
Certifications	
	TÜV Süd
	Developed and manufactured under an ISO 9001 registered system

¹ PoE = Power over Ethernet

² For directly testing relays with low level inputs by simulating signals from non conventional CTs and VTs with low level interfaces and for controlling external voltage or current amplifiers

³ THD+N: Values at 50/60 Hz, 20 kHz measurement bandwidth, nominal value, and nominal load

Order No.	Delivery contents
P0005930	Hardware: CMC 850 test set Software: IEDScout, GOOSE Configuration, Sampled Values Configuration, QuickCMC, State Sequencer and OMICRON Control Center

CMControl P – Front panel control for CMC test sets



The CMControl P is ideal for easy manual testing of protection and measuring devices with CMC test equipment. It offers much more than front panel operation in the classic sense. The device can either be attached to the CMC test set or be detached and used as a flexible handheld control. It offers a 7" touch screen and a magnetic rear for attaching to steel surfaces.

The CMControl P is available in two variants: CMControl-6 for CMC 356, CMC 256plus and CMControl-3 for CMC 353 and CMC 310.

Technical Data

Display	
Size / Type	7" WVGA (800 x 480 px) / transfective (sunlight readable)
Brightness / Contrast	400 Cd/m ² (max) / 900:1
Backlight	LED (adapts to ambient light)
Touchscreen	Capacitive with anti-glare glass
Communications interfaces	
Ethernet Connection	One rugged PoE ¹ Ethernet port: <ul style="list-style-type: none"> • 10/100 Mbit/s (10/100 Base-TX, auto-crossover) • IEEE 802.3af, Class 2 (6.49 W) powered device
USB Connection	One USB 2.0 port: <ul style="list-style-type: none"> • up to 480 Mbit/s • mass storage compliant
External power supply unit ²	
Device type	IEEE 802.3at, Power over Ethernet port injector
Nominal / permissible input voltage	100 – 240 VAC / 90 ... 264 VAC (50/60 Hz)
Max. output power	33.6 W
Environmental conditions	
Operation temperature	0 ... +50 °C (+32 ... +122 °F)
Storage temperature	-25 ... +70 °C (-13 ... +158 °F)
Humidity range	Relative humidity 5 ... 95 %, non-condensing

Equipment reliability		
The product adheres to the electromagnetic compatibility (EMC) Directive (CE conform).		
EMC Emission	International / Europe	IEC/EN 61326-1, CISPR 32/EN 55032 (Class A), IEC/EN 61000-6-4
	North America	47 CFR 15 Subpart B (Class A) of FCC
	International / Europe	IEC/EN 61326-1
EMC Immunity	The product adheres to the low voltage Directive (CE conform).	
Safety	International / Europe	IEC/EN 61010-1
	North America	UL 61010-1, CAN/CSA-C22.2 No. 61010-1
Mechanical tests	International / Europe	IEC 60068-2-6 (20 m/s ² at 10 ... 150 Hz)
		IEC 60068-2-27 (15 g/11 ms half-sine)
Mechanical data		
Weight	CMControl-3:	1.8 kg (4.0 lbs)
	CMControl-6:	2.1 kg (4.6 lbs)
Dimensions (W x H x D)	CMControl-3:	345 x 140 x 43 mm (13.6 x 5.5 x 1.7 in)
	CMControl-6:	450 x 140 x 43 mm (17.7 x 5.5 x 1.7 in)
Certifications		
		TÜV C-US (NRTL)
		Developed and manufactured under an ISO 9001 registered system
Delivery contents		
CMControl-3 or -6, USB flash drive 1 GB, Ethernet patch cable with rugged RJ45 connector 5 m (16.4 ft), Ethernet patch cable 0.75 m (2.5 ft), mounting material, soft bag		

Ordering information



	CMC ³ + CMControl P	CMControl P retrofit
CMC 356	P0000973	P0006256
CMC 256plus	P0005868	
CMC 430	-	-
CMC 353	P0005871	P0006257
CMC 310	P0005872	P0006257

If CMControl P is ordered with Test Universe along with a new CMC, refer to CMC ordering information on the corresponding product page on our website.

¹ PoE = Power over Ethernet











² For operation with CMC 356 and CMC 256plus equipped with the NET-1 control card, an external power supply unit is included in delivery. If Power over Ethernet is desired, a PoE-Upgrade for these test sets is available.

³ Without Test Universe

Accessories









Standard CMC test set accessories

The following accessories are part of the CMC standard delivery but can also be ordered separately.

Description		CMC 356	CMC 256plus	CMC 430	CMC 353	CMC 310	CMC 850
	Ethernet patch cable 1.5 m (4.9 ft), RJ45 To connect CMC test sets with Ethernet connection to PC or network (E1664300)	1	1	1	1	1	2
	Ethernet patch cable 3 m (9.8 ft), RJ45 To connect CMC test sets with Ethernet connection to PC or network (E1664400)	1	1	1	1		2
	USB connection cable, 2 m (6.6 ft), A/B To connect CMC test sets with USB connection to a PC (B1021101)	1	1	1	1	1	
	Leads with 4 mm (0.16 in) safety plugs 2 m (6.6 ft) long, 600 V (6 x red, 6 x black) (P0006168)	1	1	1	1	1	
	Flexible terminal adapters (12 x black) (E0439201)	1	1	1	1	1	
	Jumper, flexible, 6 cm (2.4 in) long (4 x black) for paralleling current triple A and B (E0439300)	1	1				
	Flexible test lead adapters with retractable sleeve 5 cm (2.0 in) long, 600 V (6 x red, 6 x black) (P0006167)	1	1	1	1	1	
	Grounding cable with battery clamp and cable lug M6 (0.24 in) 1 x 6 mm ² , 6 m (19.7 ft) (B0349701)	1	1	1	1	1	
	Soft bag for CMC 356 / CMC 256plus size device without CMControl-6 (E0074602)	1	1				
	Soft bag for CMC 356 / CMC 256plus size device with CMControl-6 (E0650301)	or 1	or 1				
	Soft bag for CMC 353 / CMC 310 size device without CMControl-3 (E0659401)					1	1
	Soft bag for CMC 353 / CMC 310 size device with CMControl-3 (E0650201)				or 1	or 1	
	Soft bag for CMC 430 (E1635901)			1			
	Bag for CMC 850 (black) (E1805500)						1

CMC wiring accessory package

B1764601

	Description	Specs.	Quantity	Order No.
	Flexible test lead adapters with 4 mm (0.15 in) safety plug for connections to narrow terminals	600 V, 32 A	12	E2106200
	Flexible test lead adapters with retractable sleeve (5 cm (2 in) long) for connections to non-safety sockets	600 V, 32 A	6 red, 6 black	P0006167
	Flexible jumpers for paralleling current triples up to 32 A or shorting neutrals of binary inputs	1000 V, 32 A	4 black	E0439300
	Crocodile clips for contacting pins or screw bolts	1000 V, 32 A	4 red, 4 black	P0006304 ¹
	Flexible terminal adapters for screw-type terminals	1000 V, 32 A	12	E0439201
	Cable lug adapters for M4 (0.15 in) screws	1000 V, 20 A	20	E0542600
	Cable lug adapters for M5 (0.2 in) screws	1000 V, 20 A	10	E0542700
	Cable ties (velcro fastener) black, 150 mm (5.9 in) long		10	
	Accessory bag		1	

Mini wireless USB adapter

E1636800



CMC 356 CMC 256plus CMC 430 CMC 353 CMC 310 CMC 850

 For wireless control of a test set:²

Standards 802.11b/g/n
 Dimensions (W x H x D) 14.9 x 7.1 x 18.5 mm (0.6 x 0.3 x 0.7 in)

Generator combination cable

CMC 356 CMC 256plus CMC 430 CMC 353 CMC 310 CMC 850



Connection between the Generator combination socket of a CMC test set or a CMS amplifier and the test object.

- > 1st end: combination plug (8-pole)
- > 2nd end: Ø 4 mm (0.16 in) safety plugs
- > 8 x 2.5 mm², 3 m (9.8 ft)
- > 3 x 32 A max continuously



Color codes yellow, green, violet, blue red, yellow, blue, black
 Order No. B1328000 B1328100

¹ P0006304 includes one red and one black crocodile clip

² Requires a CMC test set with NET-2 interface board and Test Universe 3.20 or higher. Wi-Fi is subjected to technical and legal constraints. For more information please contact your local OMICRON office or sales partner.

Transport cases

This sturdy transport case with hard-foam interior is designed for heavy transport stress and suitable for unattended shipping.

For	CMC 356, CMC 256plus, CMS 356	CMC 353, CMC 310, DANEO 400	CMC 430
			
Description	Heavy-duty transport case with wheels and extendable handle	Heavy-duty transport case with wheels and extendable handle	Heavy duty transport case with wheels, pluggable end plates, and extendable handle. The lid may be raised for use as a bench for a notebook while the test set stays in the case.
Dimension	660 x 570 x 415 mm (26 x 22.4 x 16.3 in)	570 x 490 x 415 mm (22.4 x 19.3 x 16.3 in)	476 x 476 x 502 mm (18.7 x 18.7 x 19.7 in)
Weight	11 kg (24 lbs)	9 kg (20 lbs)	18 kg (39 lbs)
Capacity	Test set, CMControl-6, accessories	Test set, CMControl-3, accessories	Test set, accessories
Order No.	B0679403	B0679500	B1636100

Trolley / Backpack

E1636000

CMC 356 CMC 256plus CMC 430 CMC 353 CMC 310 CMC 850

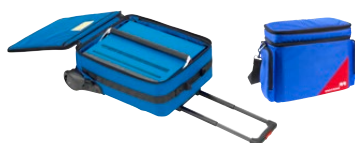

Trolley/Backpack with wheels, extendable handle and shoulder straps for transporting a CMC test set. For simple mechanical protection, not for unattended shipping.

When used for a CMC 430, accessories can be placed inside the case in addition to the device. For CMC 356¹, CMC 256plus¹, CMC 353, and CMC 310, the accessories can be transported in the roomy and capacious softbag (optionally to be ordered: E1635901) that can be easily attached onto the trolley/backpack through its trolley sleeves.

¹ Without CMControl



CMGPS 588 – Synchronization unit

P0006433

CMC 356 CMC 256plus CMC 430 CMC 353 CMC 310 CMC 850

The CMGPS 588 is an antenna-integrated GPS controlled time reference optimized for outdoor usage. It works as a Precision Time Protocol (IEEE1588/PTP) grandmaster clock and does not require any configuration work. It is automatically ready for operation within a very short time after powering the CMGPS 588 via Power over Ethernet (PoE). The distance between the CMGPS 588 and the CMC can be extended up to 95 m (312 ft) by using extension cables (B1861500: 40 m (131 ft) rugged Ethernet cable reel as extension. Two reels can be connected in series).

www.omicronenergy.com/cmgps588



CMIRIG-B – IRIG-B interface

P0006386

CMC 356 CMC 256plus CMC 430 CMC 353 CMC 310 CMC 850

CMIRIG-B is an interface box enabling the connection of devices sending or receiving the IRIG-B protocol or PPS signals with CMC test sets. CMGPS 588 can optionally be used as time reference.

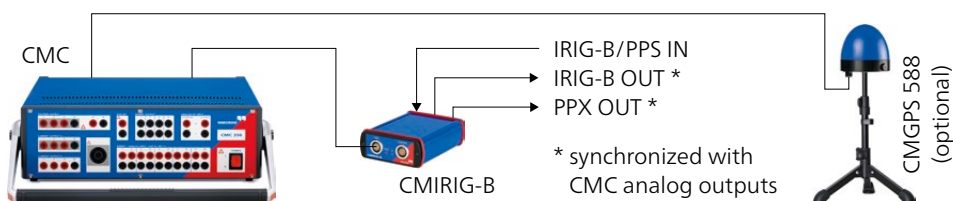

www.omicronenergy.com/cmrig-b



TICRO 100 – PTP time converter

P000604

TICRO 100 is a Precision Time Protocol time converter for deriving a high variety of time codes from IEEE 1588/PTP packages received by Ethernet. This allows for the easy synchronization of non-PTP capable equipment to the grandmaster of an IEEE 1588/PTP infrastructure.

www.omicronenergy.com/ticro100



OTMC 100p – PTP grandmaster clock

P0006508

The OTMC 100p is a GPS synchronized IEEE 1588/PTP grandmaster clock for time synchronizing IEDs and test devices via station LANs. The Power Profile (IEEE C37.238 :2017) and the Power Utility Profile (IEC/IEEE 61850-9-3:2016) are supported.

www.omicronenergy.com/otmc100



EMCON 200 – Ethernet media converter

P0006504

CMC 356 CMC 256plus CMC 430 CMC 353 CMC 310 CMC 850

EMCON 200 connects fiber glass- and copper-based networks (100 MBit/s and 1 GBit/s). SFP modules make the configuration as flexible as possible.

Time synchronization in networks with IEEE 1588/PTP is maintained. The network cable provides the power supply for the EMCON 200 using PoE (Power over Ethernet).

www.omicronenergy.com/emcon200



TWX1 – Testing traveling wave relays

P0006385

CMC 356 CMC 256plus CMC 430 CMC 353 CMC 310 CMC 850

TWX1 is the ideal field-testing solution for testing traveling wave protection relays and fault locators. Transient signals and traveling wave pulses are automatically calculated. TWX1 is operated by RelaySimTest and requires a CMC test set with NET-2 interface board.



CPOL2 – Polarity checker

P0006331

CMC 356 CMC 256plus CMC 430 CMC 353 CMC 310 CMC 850

CPOL2 Polarity Checker checks a series of terminals for correct wiring.

It offers the following functionalities and features:

- > Polarity check of current transformers and voltage transformers (CTs and VTs)
- > Polarity check of terminals and wiring connected to CTs and VTs
- > Replaces the test method that used batteries and conventional multimeters (avoids core saturation and subsequent maloperation of the protection)
- > Quick and easy assessment with green/red LED indication



CMLIB A – Low level signal connector

P0006378

CMC 356 CMC 256plus CMC 430 CMC 353 CMC 310 CMC 850

CMLIB A is used for connecting the low level signal outputs of a CMC for measurement or controlling purposes. It can also be used to connect the inputs of a CMS 356 with third party signal sources.

Connection cables can be ordered separately

- > BNC to BNC cable (E0306400)
- > BNC to 4 mm (0.16 in) banana cable (E0224500)
- > Test cables for Schneider Electric Easergy relays with sensor inputs (B1734800)



RIB1 – Low level isolation box

P0006393

CMC 356 CMC 256plus CMC 430 CMC 353 CMC 310 CMC 850

RIB1 is used to isolate the SELV low voltage signals from CMC test sets. It is connected between the low level outputs of the test set and the device under test and provides a reinforced insulation to the low level outputs of a CMC test set.



CMLIB 75x8 – Interface adapter

P0006380

CMC 356 CMC 256plus CMC 430 CMC 353 CMC 310 CMC 850

The CMLIB 75x8 is an interface adapter for connecting SIEMENS protection relays fitted with sensor inputs (e.g. SIPROTEC 7SJ81) to the low level outputs of CMC test sets. CMLIB 75x8 converts the low-level output signals of the CMC into differential (balanced) signals. In addition, the adapter also provides the simulated voltage system.



CMLIB REF6xx – Interface adapter

P0006379

CMC 356 CMC 256plus CMC 430 CMC 353 CMC 310 CMC 850

The CMLIB REF6xx is an interface adapter for connecting ABB feeder protection relays fitted with sensor inputs (e.g. REF615 or REF601) to the low level outputs of CMC test sets. For Rogowski sensor simulation, CMLIB REF6xx converts the low-level output signals of the CMC into differential (balanced) signals. In addition, the adapter also provides the simulated voltage system.



REF 54x – Cable connector for REF 54x

B0559600

CMC 356 CMC 256plus CMC 430 CMC 353 CMC 310 CMC 850

This connection cable is tailored to connect the sensor inputs of ABB protection relays of the REF 54x series (except REF542 SCU) to the low level outputs of a CMC test set.



ISIO 200 – Binary I/O terminal

P0006498

CMC 356 CMC 256plus CMC 430 CMC 353 CMC 310 CMC 850

ISIO 200 is a simple, versatile binary input/output extension for Substation Automation Systems (SAS). In the case of CMC test sets it extends the binary inputs and outputs, while as a standalone component in an SAS it receives or outputs additional binary signals. It has eight binary inputs and eight binary outputs, each in two potential groups.

The device communicates using IEC 61850 Client/Server (C/S) services and GOOSE. C/S communication connects to the process control system, whereas GOOSE is used for IEDs or CMC test sets. The configuration is performed via the integrated web interface.

The accompanying module ISIO Connect allows for the use of up to three ISIO 200 devices. Applications with more than three ISIO 200 are supported by the GOOSE configuration module (separate license required).

For more information on the benefits and applications of ISIO 200, visit www.omicronenergy.com/isio200 or refer to the ISIO 200 brochure.



RXB1 – Binary output extension

P0006392

CMC 356 CMC 256plus CMC 430 CMC 353 CMC 310 CMC 850

RXB1 is used to extend OMICRON test sets with binary relay outputs 5 to 8. Each extended binary output channel consists of a normally open (N.O.) and a normally closed (N.C.) contact.

LLX1 – Testing devices with sensor inputs

P0006381

CMC 356 CMC 256plus CMC 430 CMC 353 CMC 310 CMC 850



LLX1 is the ideal solution for testing protection and measurement devices with inputs for voltage and current sensors.

In addition to simulating the phase voltages and currents, LLX1 is also capable of simulating residual voltage and current for dedicated inputs.

A wide range of cables are available for easily connecting LLX1 to different devices that have specific connectors and pinouts:

Order No.	Cable type	Suitable for	Connector type
B1960000	LAB1	ABB Relion	RJ45
B1960100	LAB2	ABB REF542plus	2x Twin-BNC
P0000782	LAB3	ABB CSU-2	RJ45
B1960300	LSE1	Schneider Electric Sepam	RJ45
B1960500	LSE2	Schneider Electric Easergy	2x RJ45
B1960200	LSI1	Siemens Siprotec Compact	RJ45

Non-exhaustive list of available cables. For the complete list please visit our website: www.omicronenergy.com/llx1

LLX2 – Low level interface for external amplifiers and accessories

P0006382

CMC 356 CMC 256plus CMC 430 CMC 353 CMC 310 CMC 850



LLX2 provides a standard low level interface for controlling external amplifiers such as the CMS 356 and other low level accessories with a 16-pin LEMO-type connector.

LLX3 – Versatile low level outputs with 4 mm sockets

P0006383

CMC 356 CMC 256plus CMC 430 CMC 353 CMC 310 CMC 850



LLX3 provides low level outputs using standard 4 mm sockets. This makes LLX3 a flexible solution for further applications such as experimental setups.

LLX4 – Low level outputs for recloser and sectionalizer controls

P0006384

CMC 356 CMC 256plus CMC 430 CMC 353 CMC 310 CMC 850



LLX4 is used in combination with OMICRON's test cables for recloser and sectionalizer controls that are equipped with sensor inputs.



VBO3 – Voltage transformer

P0006276

CMC 356 CMC 256plus CMC 430 CMC 353 CMC 310 CMC 850

VBO3 is a three-phase voltage transformer which extends the range of application of a CMC up to 600 V (L-N).

Voltage range primary	0 ... 300 V, 3-phase
Voltage range secondary	0 ... 600 V, 3-phase
Nominal frequency	50/60 Hz
Nominal power	33 VA per phase



CMTAC 1 – AC to DC trigger rectifier

P0006278

CMC 356 CMC 256plus CMC 430 CMC 353 CMC 310 CMC 850

Renewable energy systems such as wind energy plants often do not have battery arrangements for the provision of an auxiliary DC supply. In these installations the use of AC signals for the binary outputs has become an alternative.

By means of a CMTAC 1 the AC signal is converted to DC in order to connect such an output to a binary input of a CMC test set.



C-Probe 1 – Current clamp

P0006434

CMC 356¹ CMC 256plus CMC 430 CMC 353 CMC 310 CMC 850

C-Probe 1 is an active AC and DC current probe with voltage output.

Two measuring ranges	10 A and 80 A
Frequency range	DC to 10 kHz
Accuracy	Error < 2 % for currents up to 40 A and frequencies up to 1 kHz
Phase error	< 0.5° at 50/60 Hz
Length	230 mm (9.1 in)



C-Shunt

CMC 356¹ CMC 256plus CMC 430 CMC 353 CMC 310 CMC 850

C-Shunt is a precision shunt for current measurements. It can be directly inserted into the binary/analog inputs of a test set.

	C-Shunt 1	C-Shunt 10
Electrical resistance	0.001 Ω	0.01 Ω
Resistance tolerance	0.1 %	0.1 %
Maximum current	32 A continuous	12.5 A continuous
Order No.	B0620201	B0620301



ARC 256x – Arc flash initiator

P0006279

CMC 356 CMC 256plus CMC 430 CMC 353 CMC 310 CMC 850

For testing arc flash protection systems, the ARC 256x simulates an arc flash by means of a xenon flash tube.

¹ With ELT-1 hardware option



SER 1 – Scanning equipment for relays

P0006388

CMC 356 CMC 256plus CMC 430 CMC 353 CMC 310 CMC 850

For scanning the status indication LEDs of protection relays. SER 1 consists of the OSH 256R passive optical scanning head and the interface box IFB 256 for connecting its binary outputs to one of the binary inputs of the test set.

SEM – Scanning equipment for meters

CMC 356 CMC 256plus CMC 430 CMC 353 CMC 310 CMC 850



SEM 1 – Scanning equipment for meters

SEM 1 (P0006391) contains the OSH 256 passive optical scanning head to detect the status of optical pulse LEDs of electronic energy meters. It is suitable for a wavelength range of 550 nm to 1000 nm.

This lightweight scanning head can be attached to smooth surfaces by means of its suction cup or by a re-usable adhesive rubber compound in case of a non-planar surface. The adhesive rubber compound additionally screens the sensor from ambient light.



SEM 2 – Scanning equipment for meters

SEM 2 (P0006390) contains the photoelectric scanning head TK 326 which is suitable for scanning of all known rotor marks of Ferraris meters and for scanning of optical pulse outputs of electronic meters. It is suitable for a wavelength range of 450 nm to 950 nm.



SEM 3 – Scanning equipment for meters

SEM 3 (P0006389) contains the photoelectric scanning head SH 2015 to detect pulses from electronic meters. This scanning head provides a ring magnet to attach the unit to solid-state meters. It is suitable for a wavelength range of 610 nm to 1000 nm.



CMLIB B set

CMLIB B (P0006377) provides additional connection terminals to support advanced test setups:

- > Tests with reference meters which require two pulse inputs
- > Access to binary transistor outputs of a CMC test set

Recloser and Sectionalizer Control Test Cables

For a broad range of applications in the field of recloser and sectionalizer control testing, ARCO 400 is the right choice (see page 62). For some applications of recloser control testing, an alternative solution may be more suitable: for in-depth, highly automated testing applications (for example, in R&D environments or for testing of S&C's IntelliRupter® PulseCloser® control modules) our CMC product family will represent the ideal option. Notably, CMC test sets offer the best functionality when protective relays need to be tested with the same test device as the recloser controls.

Like the ARCO 400, we also offer a unique range of test cable packages for our CMC test sets¹ for various recloser controls from different manufacturers²:

	RVP1	RST1	RCP1	RAR1	RGS1	RNU1	ROV1	RSM1	RCS1	RNO1	RTA1	RTO1	RVT1	RMI1	RIR1
Cable Pin Counts	10	14	19	24	24	24	24	24	26	32	32	32	32	42	-
Order No.	P0006175	P0006171	P0006170	P0006178	P0007087	P0006397	P0006174	P0007043	P0006395	P0006400	P0006416	P0007044	P0006394	P0006396	P0006399
Switch Type³	T&B Elastimold MVR G&W Viper SP	Cooper NOVA G&W Viper S	T&B Elastimold MVR Cooper NOVA G&W Viper S	Arteche smART RC	ABB GridShield	Schneider N-/U-/RL-/W-Series	ABB OVR/VR3S	S&C ScadaMate	Cooper NOVA-TS/STS	NOJA OSM-xx-3xx	Tavrida REC/TEL/KTR NOJA OSM-xx-2xx	Tavrida AL_2	G&W Viper ST/LT T&B Elastimold MVR	G&W Viper ST/LT T&B Elastimold MVR	Tavrida AL_4 S&C IntelliRupter
Controller															
ABB PCD							■								
ABB RER620					■										
Arteche smART P500				■											
Beckwith M-7679		■	■				■		■			■	■		
Cooper Form 4C		■	■												
Cooper Form 4D		■	■												
Cooper Form 5		■	■						■						
Cooper Form 6		■	■						■						
Cooper FXB		■													
GE DGCR													■		
GE URC		■													
ICMI URC II		■	■				■					■			
NOJA RC-01											■				
NOJA RC 10										■					
Nu-Lec PTCC						■									
S&C 5801/6801								■							
S&C IntelliRupter Controller															■
Schweitzer – SEL351R		■													
Schweitzer – SEL351R Falcon		■													
Schweitzer – SEL351RS Kestrel	■														
Schweitzer – SEL651R		■	■				■		■			■	■	■	
Siemens 7SR224															
Schneider ADVC						■									
Tavrida RC 05											■				

We also offer comprehensive OCC test templates for specific recloser controls which can be customized by the user. These templates provide access to expert knowledge on how to test various control functions in the most effective and efficient way.

¹ CMC 356, CMC 256plus, CMC 353

² Non-exhaustive list of supported controllers. For the complete list please visit our website: www.omicronenergy.com/recloser-test-cables

³ Non-exhaustive list of switches using the respective interface.

Further Testing Solutions

In addition to the products described in this brochure, the following OMICRON devices are also relevant for applications in protection and measurement equipment testing:



CMS 356

The CMS 356 is a 6-phase current and 4-phase voltage amplifier that can be used in combination with CMC test sets or in conjunction with digital real time power system network simulators.

www.omicronenergy.com/cms356



COMPANO 100

COMPANO 100 is the easy-to-use, lightweight and battery operated testing tool for all types of basic testing tasks in electrical energy systems, for example, in utilities (generation, transmission, and distribution), railway systems and industry.

www.omicronenergy.com/compano100



ARCO 400

The universal, rugged and lightweight three-phase testing solution with smart test adapters for any type of recloser control provides the fastest and easiest way to test all of the controller's functions. Additionally, GPS-synchronized tests of distribution automation schemes are also possible.

www.omicronenergy.com/arco400



DANEO 400

As described on page 38, DANEO 400 (version "Standard") is a hybrid measurement system for recording and analyzing messages in communication networks and all conventional signals. For use outside of IEC 61850 environments, the version "Basic" is a versatile tool for recording and processing analog and binary signals in substations.

www.omicronenergy.com/daneo400



CPC 100

Electrical tests on power transformers, instrument transformers, rotating machines, grounding systems, power lines, cables and circuit breakers can be performed with the CPC 100. It is the base for multiple accessories. These facilitate further applications, such as line and ground impedance measurements, as well as dissipation/power factor measurements.

www.omicronenergy.com/cpc100



CT Analyzer

The CT Analyzer determines all relevant current transformer values automatically and compares the results with the selected standard. Within seconds the device evaluates the current transformer in accordance with the relevant IEC or IEEE standard with the push of a button.

www.omicronenergy.com/ct-analyzer



VOTANO 100

VOTANO 100 can test all of the important parameters of voltage transformers quickly. It is the first portable test system that also features a high level of accuracy. The measured results are automatically assessed in accordance with IEEE and IEC standards.

www.omicronenergy.com/votano100



CIBANO 500

The circuit breaker test system CIBANO 500 combines a digital low-resistance ohmmeter, timing and travel analyzer, and a coil and motor supply in a single device. This enables all standard tests to be carried out on all types of circuit breakers.

www.omicronenergy.com/cibano500

You will find more detailed information regarding these products on www.omicronenergy.com or in the respective product brochures.

OMICRON is an international company that works passionately on ideas for making electric power systems safe and reliable. Our pioneering solutions are designed to meet our industry's current and future challenges. We always go the extra mile to empower our customers: we react to their needs, provide extraordinary local support, and share our expertise.

Within the OMICRON group, we research and develop innovative technologies for all fields in electric power systems. When it comes to electrical testing for medium- and high-voltage equipment, protection testing, digital substation testing solutions, and cybersecurity solutions, customers all over the world trust in the accuracy, speed, and quality of our user-friendly solutions.

Founded in 1984, OMICRON draws on their decades of profound expertise in the field of electric power engineering. A dedicated team of more than 900 employees provides solutions with 24/7 support at 25 locations worldwide and serves customers in more than 160 countries

For more information, additional literature, and detailed contact information of our worldwide offices please visit our website.

