

ARCO 400

Universal test set for recloser controls



Smart and rugged testing solution

Coping with modern recloser functions

Technology has significantly improved overhead distribution networks by reducing customer-minutes of interruptions through the use of modern reclosers.

While the latest control technology brings advanced functionality, including distribution automation capabilities, testing all settings to ensure proper operation has become a challenge.

What if controller testing can be done in only a few minutes?

ARCO 400, the lightweight and easy to use test set, is the universal solution for all types of recloser controls. Connecting the test set to the recloser control has never been easier: A single plug on the test set combined with intelligent recloser-specific ARCO 400 smart controller adapters allow a flawless connection within seconds. This saves time and avoids faulty wiring during the test setup.



USB and Ethernet interfaces

Changeable dust filters

LEDs indicating breaker positions for each phase

Safe and touch-proof combined test interface:
3 x 12.5 A
6 x 8 V (6 x 150 V optional)
6 binary inputs
9 binary outputs



for all types of recloser controls

Simple plug-and-play functionality checks

ARCO 400 provides the fastest and easiest way to perform simple trip/close checks. Every smart controller adapter includes a chip through which ARCO 400 automatically recognizes the specific adapter and, once connected, configures itself for the test procedure. This allows immediate basic trip and close functionality checks via the controller's push buttons – without the use of any software.

All recloser control functions covered

ARCO 400 is specifically designed to simulate the complete primary recloser component for the testing process. It enables three-phase testing of all types of recloser controls in both laboratory and field environments.

High testing flexibility

The accurate 3-phase 12.5 A current amplifiers enable both testing at very low amplitudes and the testing of functions with high fault values.

Conventional potential transformers or capacitive and resistive voltage sensors are simulated by the 6-phase voltage amplifiers and are available in either an 8 V or 150 V range. This allows testing of any voltage based function.

The test set is equipped with six binary inputs and nine binary outputs to measure trip and close commands and simulate circuit breaker auxiliary contacts.

Software based control for more functionality

ARCO 400 is operated by the ARCO Control software which can be used for simple SCADA metering checks or for the testing of any protection function, including frequency based protection functions used for load-shedding.

With the ReCoPlan software, testing procedures are standardized by creating fully automated test plans, which also reduce testing time and enable comprehensive reporting.

The wireless connection between ARCO 400 and a controlling laptop or tablet allows remote flexible operation of the test set.



Your benefits

- > Plug-and-play solution for quick and easy testing of any recloser control
- > Rugged design and usable in harsh weather conditions
- > Compact and lightweight
- > GPS synchronized automated distribution scheme tests
- > Easy-to-use software to wirelessly control ARCO 400, no special training required

www.omicronenergy.com/ARCO400

Designed to fit specific requirements

Manual control and test templates

Specific recloser and sectionalizer test modules in the ARCO Control software allow the convenient testing of any controller function. To meet your company's test requirements, ARCO 400 also enables manual testing of the controller. These tests are performed through either the given test modules or by executing a test plan predefined in ReCoPlan, which saves time and reduces complexity during site testing.

Distributed scheme testing

Several ARCO 400s can be time-synchronized to GPS and controlled simultaneously with RelaySimTest. This enables complete testing, including communication channels, by performing distribution automation scheme tests.

Rugged design for outdoor usage

Testing in the field demands the test set to be rugged and usable in harsh weather conditions. ARCO 400's robust enclosure makes it the ideal test set for any bucket truck. Special shock absorbing material lining the enclosure protects the float mounted main unit from many types of vibrations, shocks, or drops.

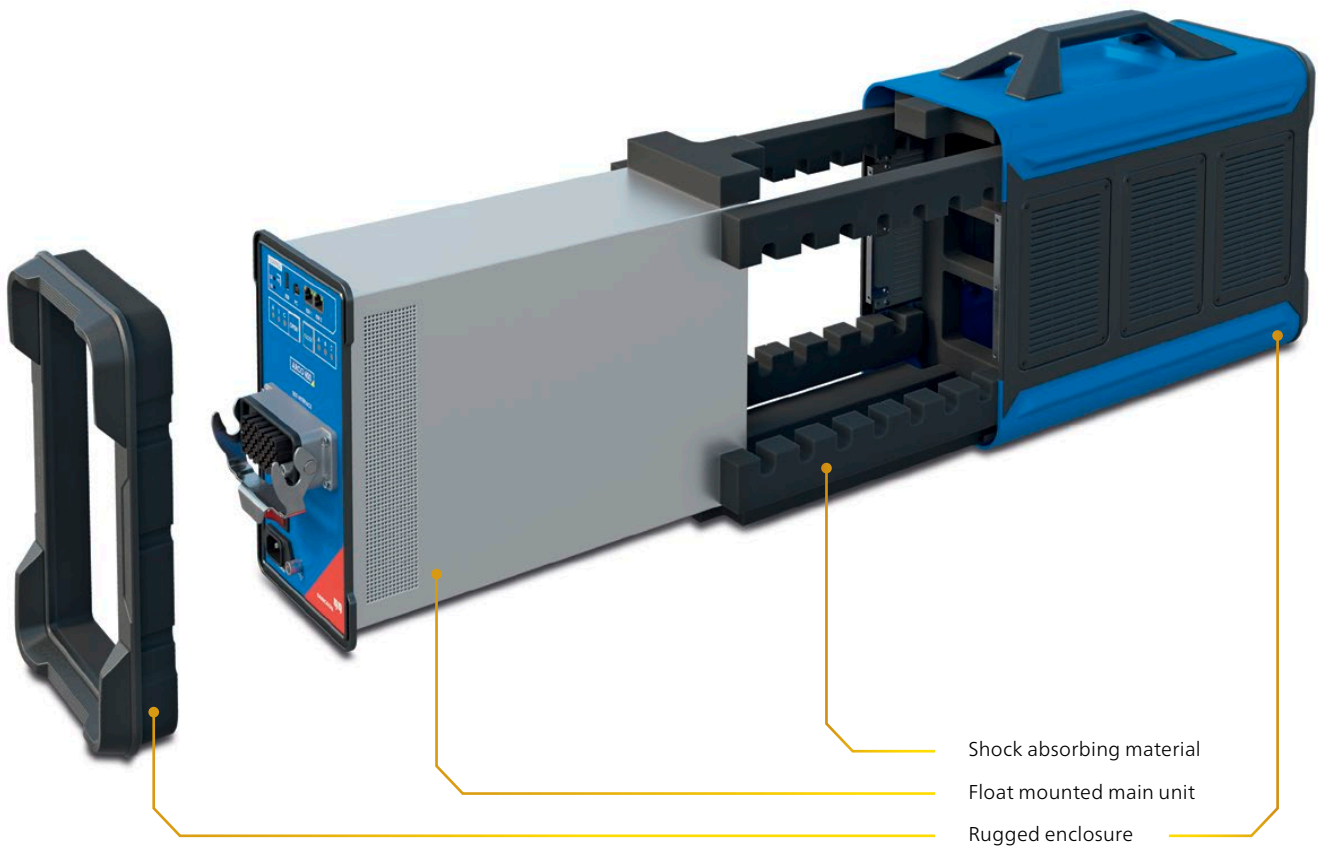

Plug-and-play setup with OMICRON Smart Connect

Safety first

The interface on ARCO 400, extension cable, and smart controller adapter leading to the test set are safe to touch. This is possible due to a new connector concept where no blank pins are exposed on either side.

Automatic detection by the ARCO Control software of a missing ground connection to the test set avoids potential dangers. Additionally the software indicates when live currents and voltages are being output.

Convenient and adaptable

The ARCO Control software allows a quick start when executing injection tests.

You can choose from a wide range of smart controller adapters for testing various recloser and sectionalizer controls – all equipped with OMICRON Smart Connect technology.

Extension cables offer either 2 m / 6.5 ft or 7 m / 23 ft to bridge the distance between the test set and the controller.

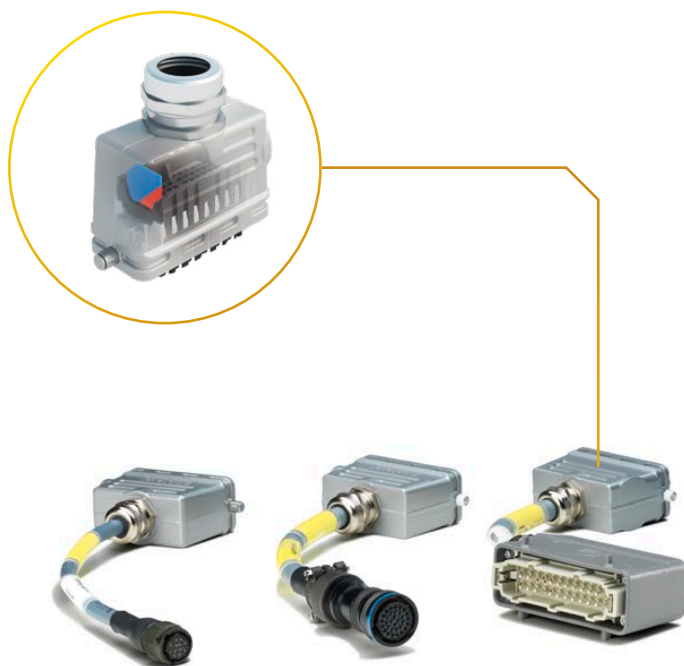
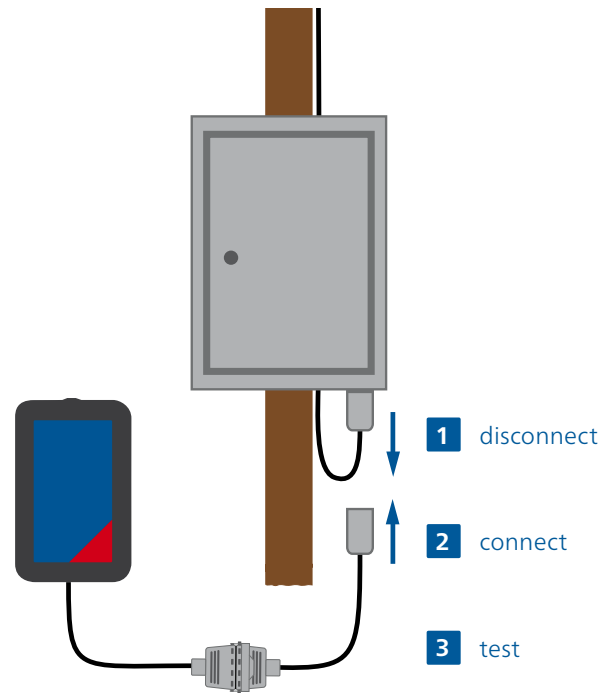

ARCO Control

Easy testing of controllers

ARCO Control, specifically designed for testing recloser and sectionalizer controls, is an easy to use software for ARCO 400. Commissioning and maintenance tests are easily performed through the software's comprehensive test tools.

The software is configured to allow quick testing of recloser and sectionalizer controls in the field.

The navigation menu guides you through each test sequence with step by step instructions. The test results are obtained quickly and reliably, and can then be exported for reporting purposes.

ARCO Control runs on a Windows Laptop/PC or Android tablet.

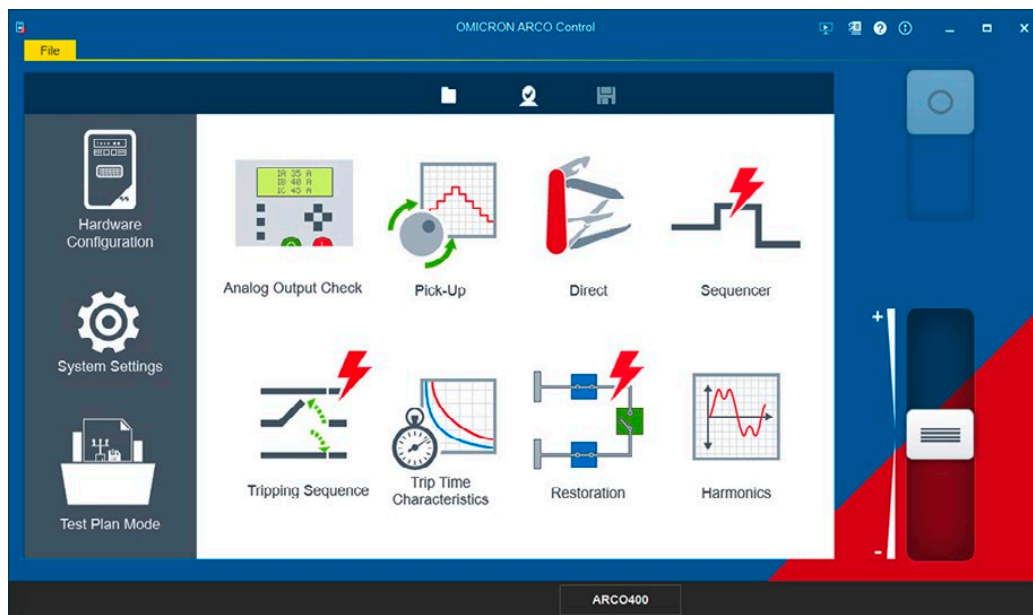

Test tools provide a wide range of functions:



The **Analog Output Check** allows the output of analog test quantities to perform simple wiring checks.

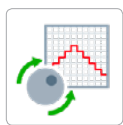

The **Pick-Up** tool is used to test the thresholds of recloser and sectionalizer control functions.



The **Direct** tool enables individual manipulation of magnitudes, phase angle and frequency of all ARCO 400 outputs for manual testing, troubleshooting, and diagnostics.



The **Sequencer** tool allows creation and execution of custom test sequences.



The **Tripping Sequence** tool tests the functionality of the device by simulating a full sequence to lockout, a successful reclose or coordination with a downstream device.

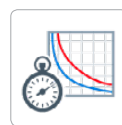

The **Trip Time Characteristics** tool checks the operating characteristics and the switching logic between a fast and slow curve.

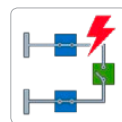

The **Restoration** tool allows testing of voltage controlled functions used in automated distribution restoration schemes.

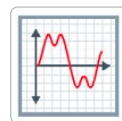

The **Harmonics** tool tests harmonic blocking or restraint functions by applying harmonics of the 2nd and/or 5th order to currents and voltages.

Plug-and-play start up procedure

Starting a new test is both easy and intuitive. Simply connect an ARCO 400 smart controller adapter and extension cable to ARCO 400 and the hardware will configure itself by reading the configuration associated with the smart adapter. After selecting the controller to be tested, the user has the option to input specific test data such as location, tester's name and report information. Tests can then be started right away by selecting the desired test tool.

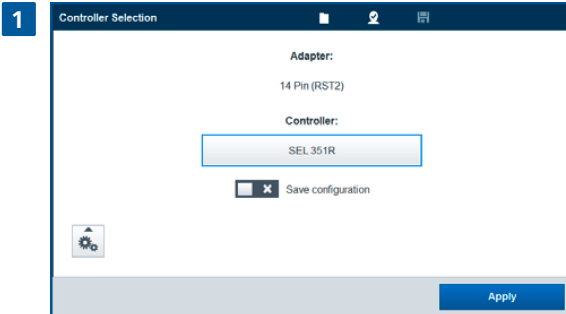

Plug in adapter

The software recognizes the smart controller adapter once it is connected. Only the controller to be tested has to be selected from the provided list.

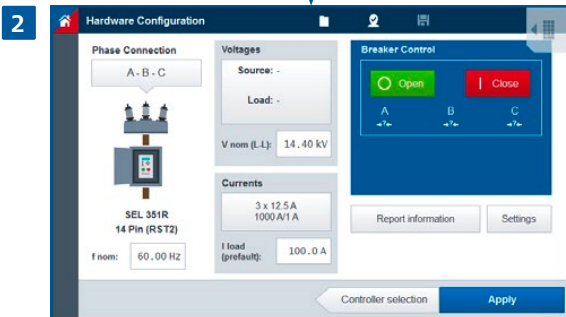
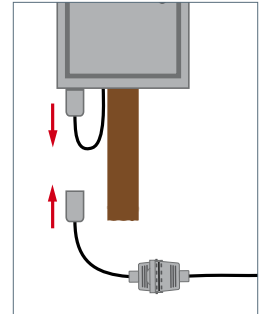

Hardware configuration

ARCO 400 amplifiers and information such as CT ratio are automatically set in the software based on the controller selection. Pre-set nominal values can be altered if required. General data can be added in the Report Information section (e.g. tester, location).

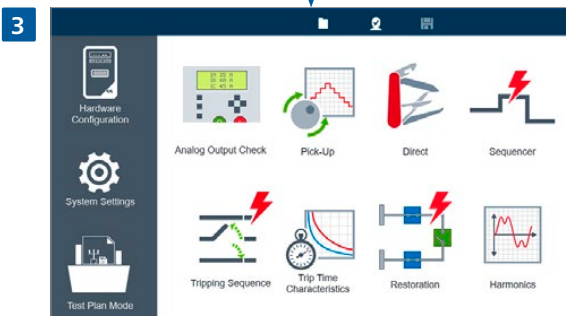
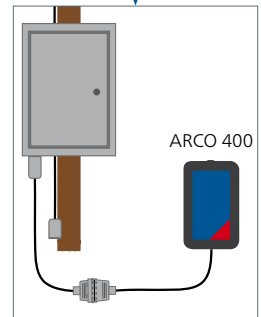

Starting a test

Select the desired test tool in the main menu to test the functions in the controller.

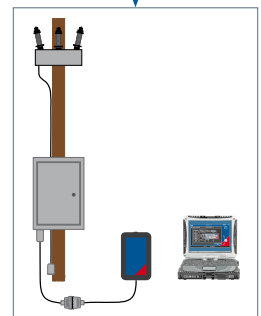

ARCO Control test examples

Tripping Sequence test tool

With this test tool, the functionality of recloser and sectionalizer controls is easily ascertained for full sequence, lockout, and automatic reclosing sequences. Sectionalizer testing simulates the trip-close sequence of an upstream device. The proper timing of the recloser or sectionalizer control is measured and included in the report.

Application mode

There are two different applications that can be tested with the Tripping Sequence test tool (recloser or sectionalizer). When selecting the DUT (device under test), the software also determines which additional units will be involved in testing. For example, the test of a recloser with a simulated downstream recloser is selected.

Configuration

The type of test sequence is defined in the configuration menu. Selectable options are Full Sequence to Lockout, Successful Reclose and Co-ordination with Downstream Recloser.

Test screen

All configured test parameters are summarized and clearly displayed. The test results are automatically assessed once the test has finished.

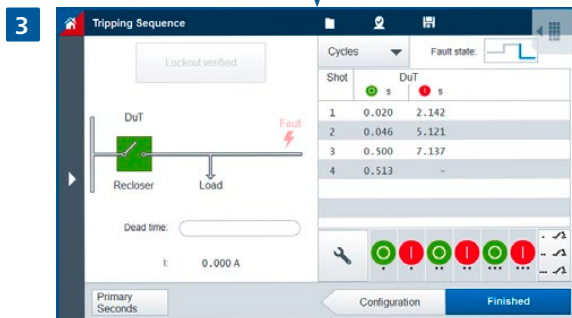
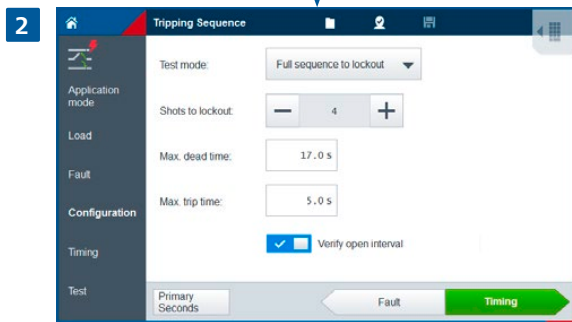
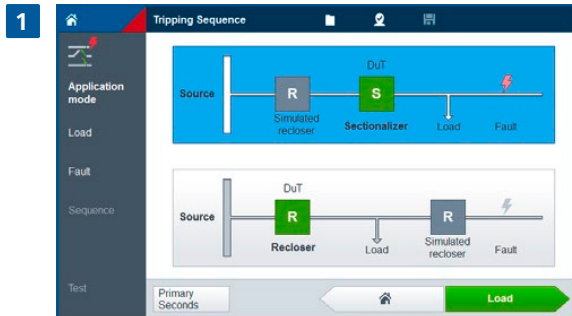

Trip Time Characteristics test tool

The Trip Time Characteristics test tool checks both the operating characteristics of the recloser control and the switch logic between the fast and slow curve which occurs when a fuse-saving scheme is applied. For this, a complete test sequence is executed up to the lock out of the controller.

To test the tripping behavior of a single curve only, repeated test shots can be sent to the controller in the Trip Only mode.

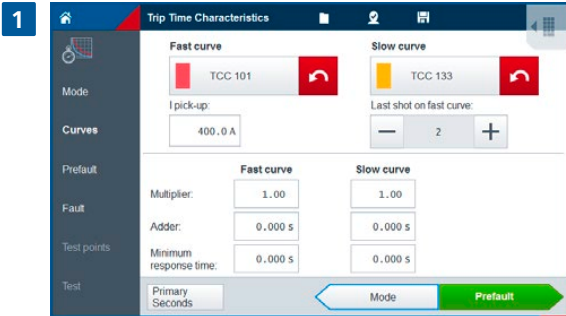

Curves

The following parameters are set in this menu:

- > The two curves to be tested
- > The optional time additions
- > The number of test shots on the fast curve
- > The current pickup value



Sequence

The test is performed as a sequence. A test sequence consists of a fixed number of shots with pre-defined currents to test the timing of the curve at different points.

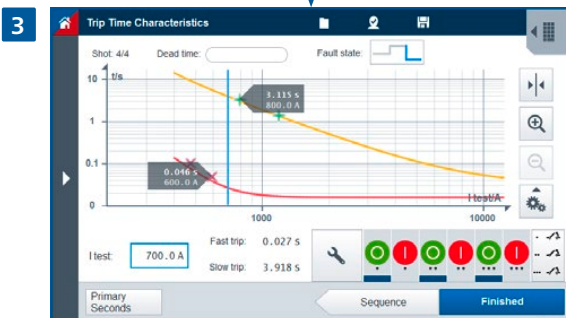

Test screen

Once the sequence is completed with all test shots, a graphic displays the shots recorded and compares them to the nominal trip times. Actual trip times are displayed for comparison and an assessment is automatically made based on defined tolerances.

ReCoPlan

Guided testing workflow

Standardized testing procedures can easily be developed through test plans which specify a predefined workflow of tests for recloser and sectionalizer controls.

Our PC-based software ReCoPlan allows you to create test plans using the available tools of ARCO Control. One additional feature with ReCoPlan is the Instruction Command which provides additional or specific information to the tester on what the test plan is to accomplish or whether an interaction is needed from the tester to complete the test procedure. Custom setting groups and values can be defined and linked to the test tools to easily modify a test plan to a recloser with different settings.

After designing the test plan in ReCoPlan, it can be saved and executed using the ARCO Control software.

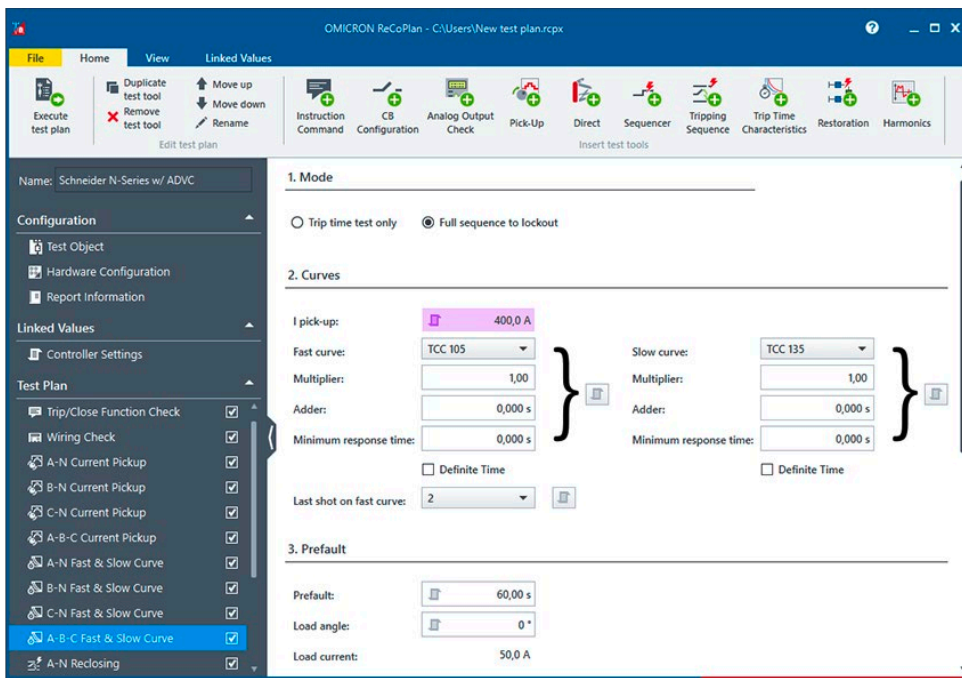

1 Create a new or open an existing test plan with ReCoPlan

New plan: Select manufacturer and controller adapter, add test tools to the plan and enter test values.

Existing plan: Easily adapt existing test plans by entering controller settings in Linked Values.

3 Get test results

Generate detailed test reports in ReCoPlan complying with the NERC (North American Electric Reliability Corporation) requirements and store or print them.

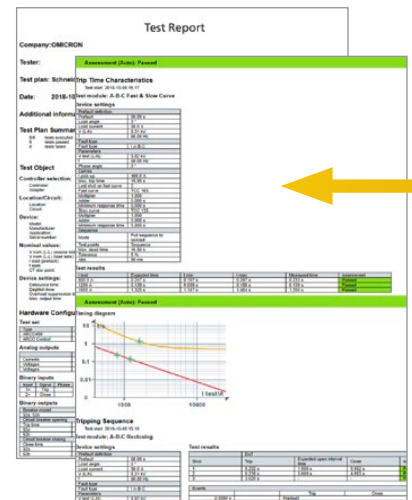



Distribute test plan or directly execute it from ReCoPlan *

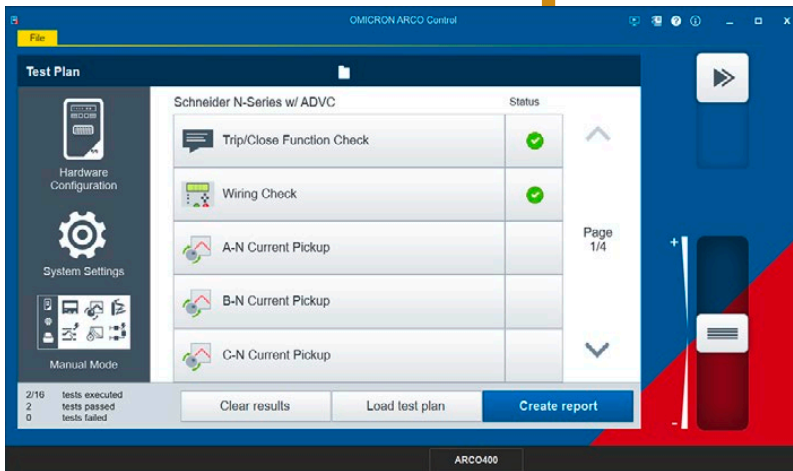

2 Execute in ARCO Control

Automatically run all pre-defined tests

Your ReCoPlan benefits

- > Fast and easy creation of test plans including pre-defined test values
- > Standardize testing procedures
- > Reduce test time
- > Include working instructions
- > One combined report
- > Quick modification to existing test plans

* If this is on a different computer, send the test plan file via email or transfer it via SD card to ARCO Control

Compliance requirements

Grid operators all over the world need to meet national compliance requirements for maintenance and documentation of the protection system. One of the hardest standards is the NERC (North American Electric Reliability Corporation) PRC-005-6.

The new NERC PRC-005-6 standard

In North America, the NERC defines test and maintenance requirements for protection systems.

The new PRC-005-6 reliability standard requires the development of a comprehensive protection system including maintenance and testing processes, replacing PRC-005-5. To be technically valid, maintenance programs require documentation showing how the verified protection system segments overlap so that no segment is left unverified.

Focus on documentation requirements

The new standard alters the process of documentation of monitoring, testing, and maintaining distribution systems, underfrequency load-shedding systems and undervoltage load-shedding systems. This includes protection systems, such as automatic reclosing and sudden pressure relaying, which affect the reliability of the Bulk Electric System (BES).

ARCO 400 provides functionality that supports all PRC-005-6 requirements.

Comply with documentation requirements

Offering user-friendly access to all information and documentation, the ADMO database software enables central planning and management of testing and maintenance activities for protection systems in the power industry.

With this database you can manage the following protection system components: auto-reclosers, protective relays, communication systems, control circuitry, current and voltage transformers, circuit breakers, station DC supplies, and energy meters.

Exchange your documents with various platforms

ADMO supports the storing and management of ARCO 400 data and testing results, as well as third-party test documents and documents individually created in Microsoft Excel, Microsoft Word or Adobe Acrobat (PDF) file formats. Graphic files can also be attached (e.g. photos of the test set-up, screenshots).

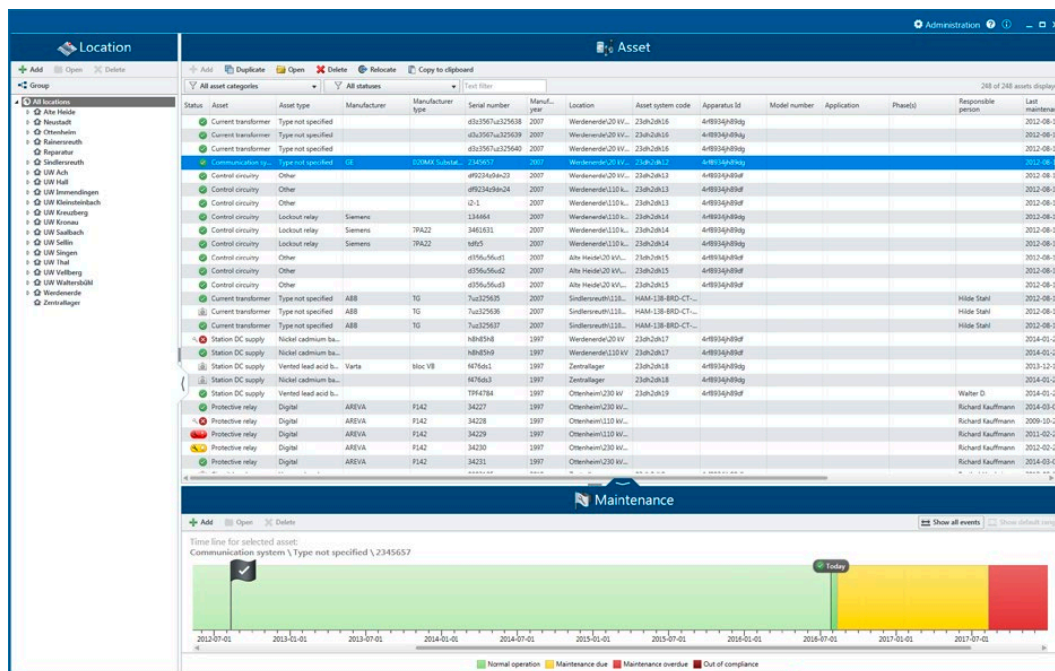

ADMO is an easy-to-use database software for central planning and management of all testing and maintenance activities for protection systems in the power industry

Distribution automation scheme testing

Testing protection and communication

With the increase of distribution automation schemes being implemented due to Smart Grid requirements, modern auto-reclosers must use complex algorithms to adapt to the network and failures. Simple function tests of single controllers are not sufficient for testing the automation functionality. Instead, synchronized injection into the controllers involved in the automation scheme is required to test not only the switching logic, but also the communication channels which are an essential part of the scheme.







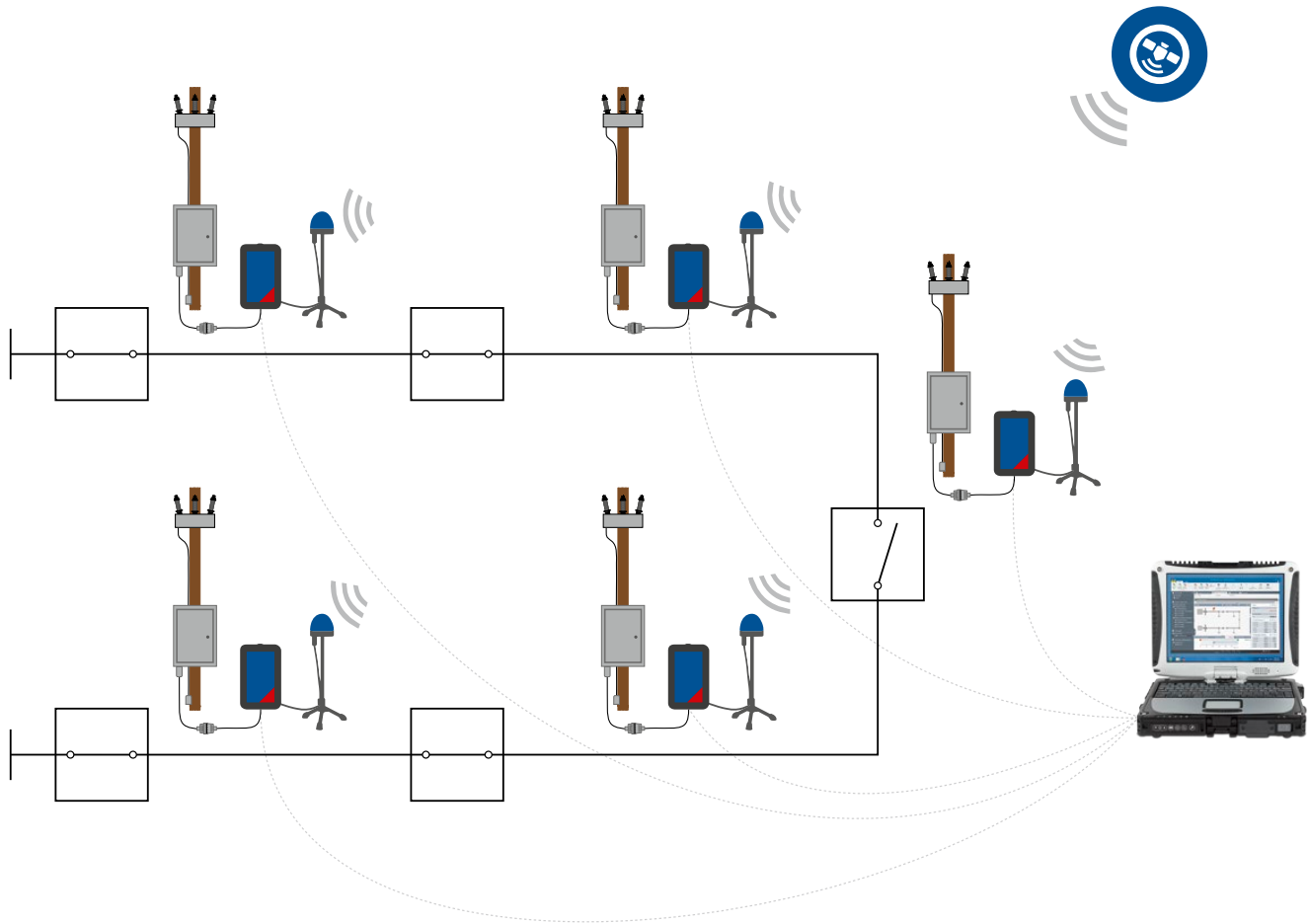





Benefit from a novel testing approach

RelaySimTest is a unique software for system-based, distributed protection testing in the field that covers these new demands. Its unique approach can reveal failures in the logic of the switching scheme as well as communication issues, requiring only a minimum amount of test steps.

System-based testing does not depend on recloser type, manufacturer, or the detailed parameters of a single controller. The correct tripping and closing behavior is the only variable that is of concern.



Ordering options

	Description	Basic P0000652	Standard P0000653	Advanced P0000654	Order No.
	ARCO 400 test set 3 x 12.5 A ARCO Control software Includes grounding cable and accessories	■	■	■	
	6 x 8 V amplifier For testing of controls that require low-energy analog voltage amplitudes	■	■	■	Choose ¹ amplifier range
	6 x 8 V and 6 x 150 V amplifiers For testing of controls that use either low-energy analog and/or conventional voltage amplitudes	or	or	or	
	Extension cable 2 m / 6.5 ft To connect the ARCO 400 to a Controller Adapter	■	■	■	Choose ¹ cable length
	Extension cable 7 m / 23 ft To connect the ARCO 400 to a Controller Adapter	or	or	or	
	ReCoPlan license for ARCO 400 Enables creation and execution of test plans to standardize testing procedures and reduce testing time		■	■	P0006610
	RelaySimTest license for ARCO 400 Enables synchronized distributed scheme testing with RelaySimTest			■	P0008699
	CMGPS 588 synchronization unit Accessory to time-synchronize the ARCO 400			■	P0006433
	RVO2 Voltage generator combination cable To wire voltages into a controller with external voltage inputs (only for supported adapters)				P0006181
	BOB2 Breakout box To access the ARCO 400 inputs and outputs via 4 mm/0.15 in banana plugs				P0006420
	Carry bag Holds ARCO 400 accessories, extension cable and several Controller Adapters	■	■	■	E1445801
	Transport case For ARCO 400 and carry bag				B1445902

¹ during test set configuration

ARCO 400 smart controller adapters

ARCO 400 smart controller adapters with OMICRON Smart Connect technology are offered for testing of recloser and sectionalizer controls with different pin interfaces. This enables testing of the widest range of controllers including:

	Pin Count	Switch/Breaker type	Suitable for controllers such as	Adapter	Order No.
	10	G&W Viper SP T&B Elastimold MVR	SEL 351RS Kestrel	RVP2 ^{1,2}	P0006414
	14	Cooper NOVA G&W Viper S T&B Elastimold MVR	Eaton/Cooper Form 4C, 4D, 5, 6 SEL 351R, 651R, 651RA	RST2 ^{1,2}	P0006401
	19	Cooper NOVA G&W Viper S	Eaton/Cooper Form 4C, 4D, 5, 6 SEL 651R	RCP2 ^{1,2}	P0006402
	24	ABB GridShield	ABB RER620	RGS2 ^{1,2}	P0006411
	24	Schneider N-/U-/RL-/W-Series	Schneider ADVC Nu-Lec PTCC	RNU2	P0006405
	24	ABB OVR-3/3SP ABB VR-3S	ABB PCD ³ SEL 651R	ROV2 ^{1,2}	P0006412
	24	S&C ScadaMate	S&C 5801 S&C 6801	RSM2 ²	P0006413
	26	Cooper NOVA-TS/STS	Eaton/Cooper TS/STS Eaton/Cooper Form 5, 6 SEL 651R	RCS2 ^{1,2}	P0006403
	32	NOJA OSM-xx-3xx	NOJA RC 10	RNO2	P0006407
	32	Tavrida REC/TEL/KTR NOJA OSM-xx-2xx	Tavrida RC 05 NOJA RC-01	RTA2	P0006408
	32	Tavrida AI_2	SEL 651R	RTO2	P0006406
	32	G&W Viper ST/LT T&B Elastimold MVR	SEL 651R	RVT2 ^{1,2}	P0006404
	40	Siemens 3AD Siemens SDR	Siemens 7SR224, 7SC80 SEL 651R	RSR2 ^{1,2}	P0006421
	42	G&W Viper ST/LT T&B Elastimold MVR Tavrida AI_4	SEL 651R	RMI2	P0006409

For a full list of available adapters please check our website www.omicronenergy.com/arco400 or contact us.

¹ Requires RVO2 Voltage Generator Combination Cable (see page 14) if controller is equipped with a separate voltage input connector

² Possibly requires the ARCO 400 to be equipped with the 6 x 150 V Option (see page 14)

³ Only controllers without the block close function from yellow handle (69 switch) are supported

Technical data ARCO 400

ARCO 400

Current amplifier

Number of outputs	3	
Ranges	Range I: 0 ... 1.25 A Range II: 0 ... 12.5 A Range III: 0 ... 8 V	
Frequency range	0 ... 599 Hz	
Amplitude accuracy		
	Error typical	Error guaranteed
50/60 Hz	< 0.04 % of rd. ¹ + 0.01 % of rg. ¹	< 0.08 % of rd. + 0.02 % of rg.
THD+N at 50/60Hz	< 0.1 %	< 0.25 %
Phase error to UTC		
50/60 Hz	< 0.05°	< 0.2°
DC offset		
Range I	< 100 µA	< 300 µA
Range II	< 1 mA	< 3 mA
DC resolution		
Range I	< 100 µA	
Range II	< 1 mA	
Output power		
Compliance voltage	> 12 V (RMS) > 18 V (DC)	
Output power AC	Typical: 3 x 95 W at 9 A ... 12.5 A Guaranteed: 3 x 85 W at 8 A ... 12.5 A	

Voltage amplifier

Number of outputs	6	
Ranges	Range I: 0 ... 8 V Range II ² : 0 ... 150 V	
Frequency range	0 ... 599 Hz	
Amplitude accuracy		
	Error typical	Error guaranteed
50/60 Hz	< 0.04 % of rd. + 0.01 % of rg.	< 0.08 % of rd. + 0.02 % of rg.
THD+N at 50/60Hz	< 0.1 %	< 0.25 %
Phase error to UTC		
50/60 Hz	< 0.05°	< 0.2°
DC offset		
Range I	< 500 µV	< 1 mV
Range II	< 10 mV	< 20 mV
DC resolution		
Range I	< 500 µV	
Range II	< 10 mV	
Output power (Range II)		
Per channel	Typical: 280 mA Guaranteed: 250 mA	
Output power AC	Typical: 3 x 42 W at 150 V Guaranteed: 3 x 37.5 W at 150 V	

¹ rd. = reading, rg. = range

² Hardware option



Binary inputs

Number of binary inputs	6
Number of potential groups	6
Type	Wet
Sampling frequency	10 kHz
Time resolution	100 μ s
Rated input voltage	250 V CAT III
Resolution	1 V
Threshold voltage range	5 ... 250 V
Input impedance	Configurable
Insulation	6 galvanically isolated binary inputs

Binary output relays

Number of binary outputs	9
Number of potential groups	3
Type	Potential-free contacts, NO
Contact rating	250 V / 0.5 A
Total make time	< 6 ms
Total break time	< 3 ms

Environmental conditions

Operating temperature	-10 °C ... +50 °C / +14 °F ... +122 °F
Storage and transportation	-25 °C ... +70 °C / -13 °F ... +158 °F

Maximum altitude

Operating	4 000 m / 13 000 ft
Non-operating	15 000 m / 49 000 ft
Humidity	5 % ... 95 % relative humidity; no condensation

Equipment reliability

EMC	IEC 61326-1, CISPR 22, FCC Subpart B of Part 15 Class A
Shock	30 g (11 ms half sine) according to IEC 60068-2-7
Vibration	5 g (10 Hz – 2000 Hz) according to IEC 60068-2-64
Drop test	2 drops (transport position) 0.5 m / 1.6 ft IEC 60068-2-31

Power supply and mechanical data

Single-phase, nominal	100 ... 240 VAC
Single-phase, permissible	85 ... 264 VAC
Current, nominal	10 A max. at < 170 V 8 A max. at > 170 V
Frequency, nominal	50/60 Hz
Weight	10 kg / 22 lbs
Dimensions (W x H x D)	200 x 350 x 455 mm / 7.9 x 13.8 x 17.9 in
Ingress protection rating	IP31 (IP32 with front cover)

All input / output values are guaranteed for one year within an ambient temperature of 23 °C \pm 5 °C / 73 °F \pm 10 °F. Accuracy values indicate that the error is smaller than \pm [(read value x reading error) + (range setting x range error)].

We create customer value through ...

Quality

You can rely on the highest safety and security standards



Superior reliability with up to

72

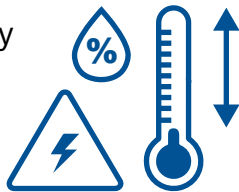

hours burn-in tests before delivery

100%

routine testing for all test set components



ISO 9001
TÜV & EMAS
ISO 14001
OHSAS 18001



Compliance with international standards

Innovation



... a product portfolio tailored to my needs

More than

200

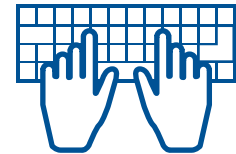

developers

keep our solutions up-to-date

More than

15%

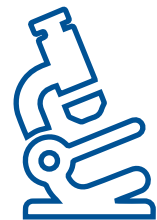

of our annual sales is reinvested in research and development

Save up to

70%



testing time through templates, and automation

— Support —

24/7

Professional technical support at any time

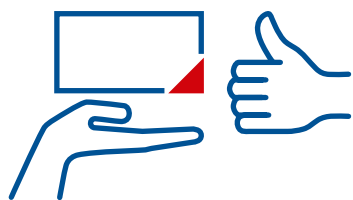

Loaner devices help to reduce downtime

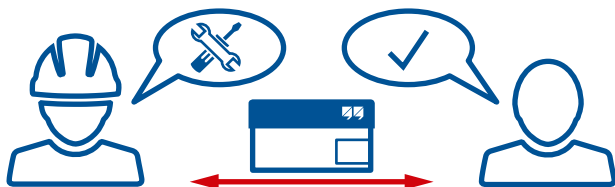

Cost-effective and straight-forward repair and calibration

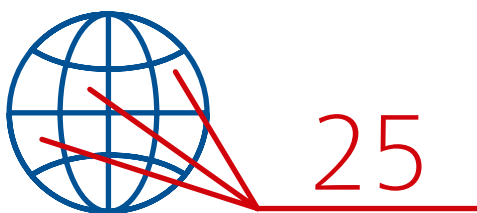

offices worldwide for local contact and support

— Knowledge —

More than

300



Academy and numerous hands-on trainings per year

Frequently OMICRON hosted user meetings, seminars and conferences



to thousands of technical papers and application notes

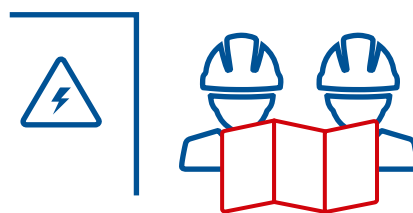

Extensive expertise in consulting, testing and diagnostics

OMICRON is an international company that works passionately on ideas for making electric power systems safe and reliable. Our pioneering solutions are designed to meet our industry's current and future challenges. We always go the extra mile to empower our customers: we react to their needs, provide extraordinary local support, and share our expertise.

Within the OMICRON group, we research and develop innovative technologies for all fields in electric power systems. When it comes to electrical testing for medium- and high-voltage equipment, protection testing, digital substation testing solutions, and cybersecurity solutions, customers all over the world trust in the accuracy, speed, and quality of our user-friendly solutions.

Founded in 1984, OMICRON draws on their decades of profound expertise in the field of electric power engineering. A dedicated team of more than 900 employees provides solutions with 24/7 support at 25 locations worldwide and serves customers in more than 160 countries.

The following publications provide further information on the solutions described in this brochure:

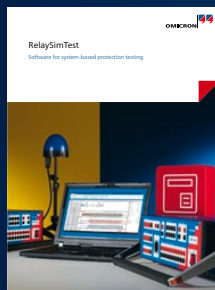

RelaySimTest



ADMO

For more information, additional literature, and detailed contact information of our worldwide offices please visit our website.

